

# RONIN-MX User Manual

V1.0 2016.05

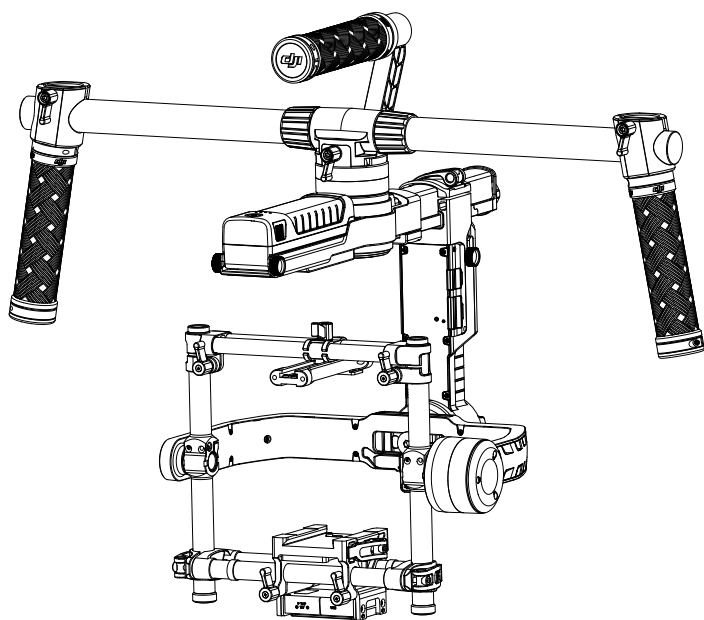

### **Searching for Keywords**

Search for keywords such as “battery” and “install” to find a topic. If you are using Adobe Acrobat Reader to read this document, press Ctrl+F on Windows or Command+F on Mac to begin a search.

### **Navigating to a Topic**

View a complete list of topics in the table of contents. Click on a topic to navigate to that section.

### **Printing this Document**

This document supports high resolution printing.

# Disclaimer and Warning

Congratulations on purchasing your new DJI™ product. The information in this document affects your safety and your legal rights and responsibilities. Read this entire document carefully to ensure proper configuration before use. Failure to read and follow instructions and warnings in this document may result in serious injury to yourself or others, or damage to your DJI product or damage to other objects in the vicinity. This User Manual and all other collateral documents are subject to change at the sole discretion of DJI. For up-to-date product information, visit <http://www.dji.com> and click on the product page for this product.

Do not modify or adjust the Ronin™-MX.

The Ronin-MX has been calibrated before it leaves the factory. No modification or adjustment of the Ronin-MX is required or recommended. Be sure to use the original battery, otherwise performance may be hindered and internal malfunctions or damage may occur. Please download the corresponding Assistant.





By using this product, you hereby signify that you have read this disclaimer and warning carefully and that you understand and agree to abide by the terms and conditions herein. You agree that you are solely responsible for your own conduct while using this product, and for any consequences thereof. You agree to use this product only for purposes that are proper and in accordance with all applicable laws, rules, and regulations, and all terms, precautions, practices, policies and guidelines DJI has made and may make available.

DJI accepts no liability for damage, injury or any legal responsibility incurred directly or indirectly from the use of this product. The user shall observe safe and lawful practices including, but not limited to, those set forth in this User Manual.

DJI is a trademark of SZ DJI Technology Co., Ltd. (abbreviated as “DJI”) and its affiliated companies. Names of products, brands, etc., appearing in this manual are trademarks or registered trademarks of their respective owner companies.

## Using this Manual

### Legend

-  **WARNING** Warning: Failure to properly follow procedures may result in property damage, collateral damage, and serious or superficial injury.
-  **CAUTION** Caution: Failure to properly follow procedures may result in property damage and serious injury.
-  **NOTICE** Notice: Failure to properly follow procedures may result in property damage, a small possibility of injury, or no possibility of injury.
-  **TIPS** Tips

## Before You Begin

The following documents have been produced to help you safely operate and make full use of your Ronin-MX:

*Ronin-MX Quick Start Guide*

*Ronin-MX User Manual*

*Ronin-MX Intelligent Battery Safety Guidelines*

Confirm that all parts listed in the In the Box section below are included in your box. Read this entire User Manual and watch the informational and tutorial videos on the product page of DJI's official website (<http://www.dji.com/product/ronin-mx>). Read the disclaimers and warnings above to understand your legal rights and responsibilities. If you have any questions or problems during the installation, maintenance or use of this product, please contact DJI or a DJI authorized dealer.

## Download the DJI Assistant (or DJI Ronin Assistant) App

Download and install the DJI Assistant (for iOS) app or the DJI Ronin Assistant (for Android) app.

Note: Although the iOS version of the app is called "DJI Assistant" and the Android version is called "DJI Ronin Assistant", both versions of the app have the same functions.

Search "DJI Assistant" on the App Store and then follow instructions for iOS installation. Search "DJI Ronin" on Google Play and then follow instructions for Android installation.



iOS 7.1 or above



Android 4.3 or above



<http://m.dji.net/dji-ronin>



For the best experience, use a mobile device that runs iOS 7.1 or Android 4.3, or a later version.

---

# Contents

Disclaimer and Warning	1
Using this Manual	1
Legend	1
Before You Begin	2
Download the DJI Assistant (or DJI Ronin Assistant) App	2
Introduction	4
In the Box	5
Ronin-MX Diagram	7
Getting Started	8
Tuning Stand	8
Assembling the Handle Bar	8
Installing the Handle Bar onto the Gimbal	9
DJI Intelligent Battery	9
Mounting the Camera	12
Configuring the Handle Bar	15
Balancing	15
Step 1: Balancing the Vertical Tilt	15
Step 2: Balancing the Roll Axis	16
Step 3: Balancing the Tilt Axis	16
Step 4: Balancing the Pan Axis	17
Advanced Roll Adjustment	17
Using the Ronin-MX on the Ground	18
Tuning with the DJI Assistant (or DJI Ronin Assistant) App	18
Tuning with the DJI Assistant Software for PC/MAC	26
Remote Controller Operation	33
Operation Modes	36
Using with the Matrice 600	37
Mounting the Ronin-MX onto the Matrice 600	37
DJI GO App Tuning	40
Remote Controller Operation	42
Adding a Third-Party Transmitter/Receiver	43
Maintenance	43
Troubleshooting	44
Specifications	45
Compliance Notice	46

## Introduction

Developed for filmmaking professionals, the DJI Ronin-MX is designed for both handheld use and mounting to a DJI Matrice 600 aircraft for capturing amazing footage from the air. It can also be used on moving vehicles, camera jibs or wirecams. The technology built into the DJI Ronin-MX allows a broad spectrum of camera setups of varying sizes and weights to be stabilized during filming.

The built in slip ring on the Ronin-MX allows for 360 degrees of continuous rotation. When used with the DJI SRW-60G, the Ronin-MX can rotate unobstructed while transmitting HD video. It can also be connected to DJI Lightbridge 2 for long range video transmission during aerial use. The Ronin-MX is also compatible with the DJI Focus.

The brushless gimbal stabilization system is more than just three brushless motors moving on three axes. The motors work with position feedback and the IMU (Inertial Measurement Unit) to communicate with DJI's custom-built 32-bit processor, which processes movement calculations in milliseconds. This reduces angular vibration to less than  $0.02^\circ$  of translated movement, meaning that the camera will remain steady and the motor can be absolutely silent. The Ronin-MX can be used in different operation modes such as Underslung Mode, Upright Mode and Briefcase Mode.

## In the Box

### Gimbal ×1

The gimbal includes DJI's built-in motor drive modules, an independent IMU module, a 32-bit DSP processor, a power supply module, a Bluetooth module, a transmitter/receiver module, a camera shelf, a power breakout box and slip ring.

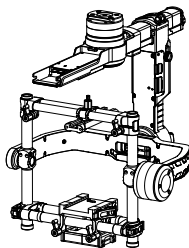

### Handle Bar ×1

Customizable handle bar for the gimbal. The handle bar is assembled from five parts, including a top handle, two bars and two grips.



### Remote Controller – 2.4 GHz ×1

Control the gimbal's movements, switch working modes, and select gimbal speed.



### Tuning Stand ×1

For suspending or storing the gimbal.

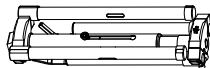

### Charger ×1

100-240V automatic switching charger.



### DJI Intelligent Battery ×2

Power source for the gimbal as well as other external devices, including the DJI Focus, Lightbridge, etc.

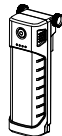

### Cable Pack ×1

ANSI cable:  
JIS or CE cable (varies by region)



### Micro USB Cable x1

For firmware upgrades.



### CAN Cable x1

For connecting the gimbal to the Matrice 600.



### Camera Mounting Plate x1

For mounting your camera onto the gimbal.



### Camera Upper Mounting Plate x1

For mounting your camera onto the gimbal.



### Vibration Absorber x1

For mounting the gimbal onto the Matrice 600 and reducing aircraft vibrations. The gimbal connector can be removed and mounted to other devices such as camera jibs or wirecams by using the 1/4"-20 or 3/8"-16 screws.

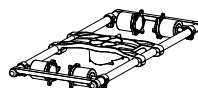

### Accessories Package x1

Camera Screw A (1/4") x2



Camera Screw B (3/8") x2



Camera Screw C (1/4") x2



Camera Screw D (3/8") x2



Lens Support x1



Lens Support Screw x1



Allen Wrench x3 (2 mm, 3 mm, 3/16")



Vibration Absorber Screw x12



Camera Upper Mounting Plate Screw x2





# Ronin-MX Diagram

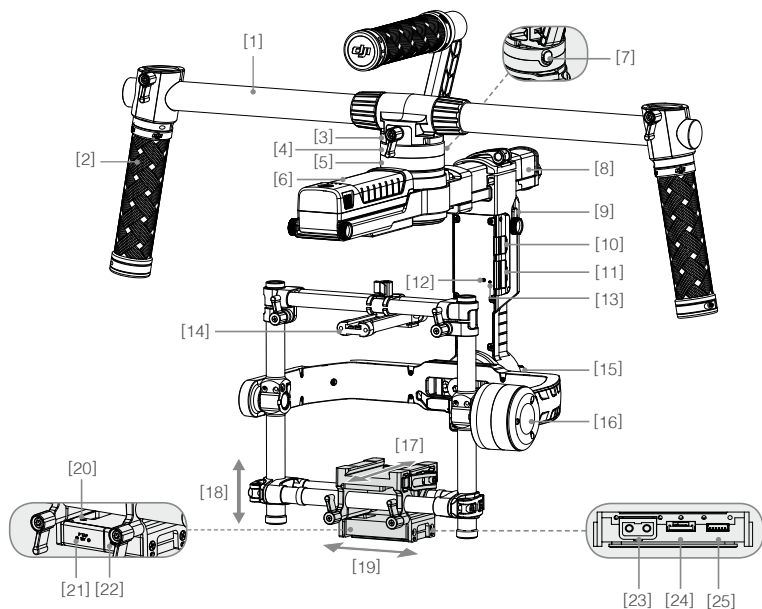

- |  |   |
|--|---|
| [1] Top Handle Bar                                       | [13] Gimbal LED Indicator                   |
| [2] Side Handle  | [14] Camera Upper Mounting Plate            |
| [3] Gimbal Connector                                     | [15] Roll Motor                             |
| [4] CAN2 Bus Port  | [16] Tilt Motor                             |
| [5] Pan Motor  | [17] Fore and Aft Adjustment                |
| [6] DJI Intelligent Battery                              | [18] Tilt Vertical Adjustment               |
| [7] Safety Lock  | [19] Roll Adjustment                        |
| [8] Pan Adjustment Slider                                | [20] IMU Port                               |
| [9] Intelligent Battery Power Distributor Mounting Plate | [21] P-TAP Accessory Power Port             |
| [10] D-BUS Receiver Port                                 | [22] USB Accessory Power Port               |
| [11] Micro USB Port & CAN1 Bus Port                      | [23] P-TAP Accessory Power Port (rear side) |
| [12] Bind Button   | [24] DJI Lightbridge Port (rear side)       |
|  | [25] GCU Port (rear side)                   |

# Getting Started

## Tuning Stand

You can use the tuning stand to hold the Ronin-MX during setup or for storage. To unfold the tuning stand, follow the steps below.

1. Hold the stand in the upright position as shown in the picture below and tighten the knob.
2. Press the buttons [1] on the outside of the lower legs and rotate the legs downwards, away from the stand. Then press the buttons [2] on the outside of the upper support arms and pull them upwards, away from the stand. Press the button [3] on the vertical support and slide it up to extend the stand, as shown.
3. The upper half of this tuning stand can be removed by loosening the knob on the rear of the stand. You can use it with any C-stand style stud that fits into the hole where the support arms converge.

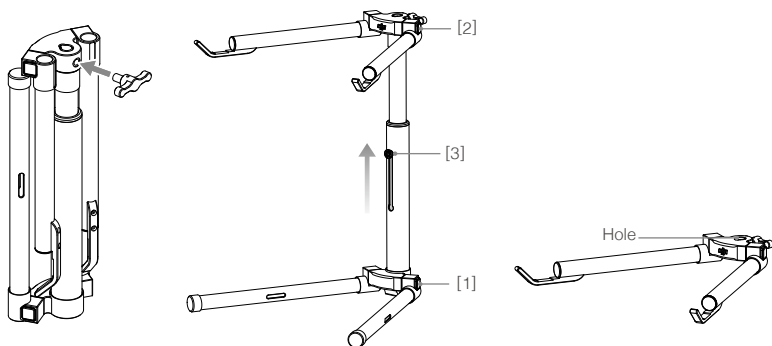

### NOTICE

- When mounting this section to a C-stand, always be sure to check the balance of the stand so that the Ronin-MX, if it is fitted with a camera, does not tip over.
- When setting on a table, make sure the table is flat and level.

## Assembling the Handle Bar

1. Attach the bars to both sides of the top handle by tightening the grip screws.



2. Attach the grips to the bar and lock them in the preferred position.



## Installing the Handle Bar onto the Gimbal

1. Place the handle bar in position, as shown below, then slide the gimbal horizontally into the handle bar, tighten the knob when you hear a "click", which indicates that the safety lock has engaged.
2. Holding the gimbal by the grips, make sure the gimbal is not obstructed during a 360 degree pan. The installation is complete.

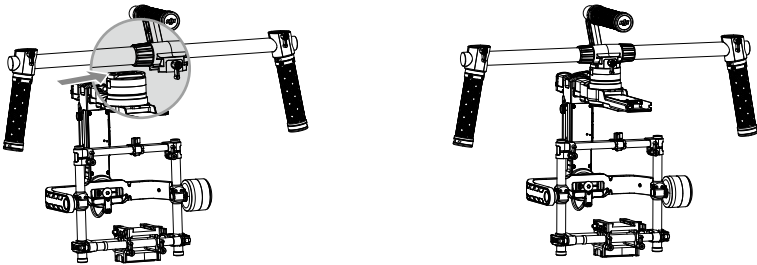

**NOTICE**

To remove the gimbal, pull down the safety lock and then loosen the knob.

## DJI Intelligent Battery

Before you start using your Ronin-MX, be sure to charge the battery. The DJI Intelligent Battery was specially designed for the Ronin-MX. It has a capacity of 1580 mAh, a voltage of 14.4 V, and a variety of power management functions. Only charge the DJI Intelligent Battery with the DJI approved Charger (MODEL BC235144015). When the DJI Intelligent Battery is fully charged, the Ronin-MX has a maximum run-time of three hours.



DJI Intelligent Battery

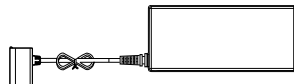

Charger

### DJI Intelligent Battery Functions

Balanced Charging	Automatically balances the voltage of each battery cell during charging.
Battery Level Display	Displays current battery levels.
Overcharge Protection	Charging stops automatically when the battery voltage is too high.
Over-Discharge Protection	Discharging stops automatically when battery voltage is too low.
Short-Circuit Protection	Automatically cuts power supply when a short circuit is detected.
Sleep Protection	Sleep mode is activated after 20 minutes of inactivity, saving power.
Charging Temperature Detection	The battery will charge only when the temperature is between 32° F and 131° F (0° C and 55° C).

### Battery Specifications

Type	LiPo
Capacity	1580 mAh
Voltage	14.4 V
Charging Environment Temperature	40° to 104° F (5° to 40° C)
Operating Environment Temperature	14° to 104° F (-10° to 40° C)
Charging/Discharging Environment Relative Humidity	< 80%

- ⚠️ WARNING**
- Read the User Manual, Disclaimer, and Battery Safety Guidelines before use. Users take full responsibility for all operations and usage.
  - Always use DJI approved chargers. DJI takes no responsibility for any consequences resulting from the use of non-DJI approved chargers.

## Charging the DJI Intelligent Battery

1. Connect the Charger to a wall socket (100-240V, 50/60Hz).
2. Connect the DJI Intelligent Battery to the Charger.
3. The battery level indicator lights display the current charge level as the DJI Intelligent Battery charges.
4. The DJI Intelligent Battery is fully charged when the battery level indicator lights turn off. Disconnect the battery from the charger when charging is complete.



## Using the DJI Intelligent Battery

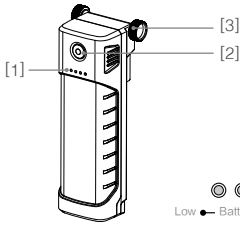

- [1] Battery Level Indicators
- [2] Power Button (with LED indicator)
- [3] Thumb Screws

**Checking the Battery Level:** When the DJI Intelligent Battery is turned off, pressing the battery power button once will display the current battery level.

**Powering On:** When the DJI Intelligent Battery is turned off, press and hold the power button for 1 second to turn on the DJI Intelligent Battery.

**Powering Off:** When the DJI Intelligent Battery is turned on, press and hold the power button for 1 second to turn off the DJI Intelligent Battery.

## DJI Intelligent Battery Installation

1. Loosen the screws on either side of the DJI Intelligent Battery. Slide the DJI Intelligent Battery directly into the top part of the gimbal in front of the pan motor and then tighten the thumb screws. Be sure the battery's thumb screws fit into the positioning slots so that the DJI Intelligent Battery makes full contact with the gimbal's electrical leads.
2. Tighten the screws on the DJI Intelligent Battery to lock it in place.

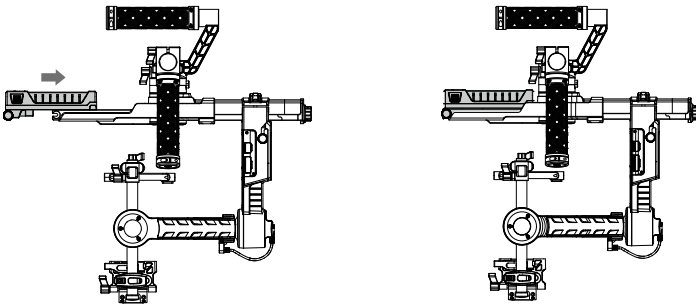

- Make sure the DJI Intelligent Battery is turned off during installation.
- An incorrectly installed battery may lead to (1) Dropping out during flight, (2) Poor battery connection, or (3) Unavailable battery information.

3. The optional Intelligent Battery Power Distributor with an Intelligent Battery is mounted here to supply power to your camera or other accessories if needed.

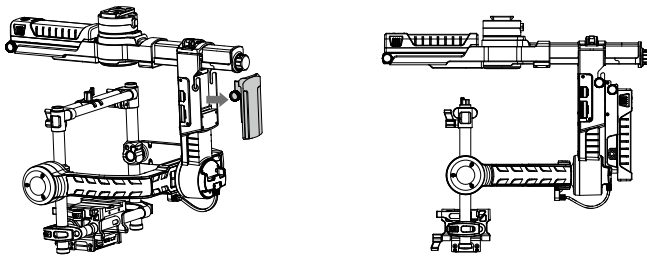

- Visit the Official DJI Online Store to learn more about the Intelligent Battery Power Distributor.
- Note that the Intelligent Battery Power Distributor can only supply power to the camera or other accessories and will not power the Ronin-MX.



If using the P-TAP Accessory Power Port at the bottom of the Ronin-MX as a power source for your camera or accessory, make sure the combined total P-TAP output is below 3 A. Do not use the P-TAP Accessory Power Port to supply power for RED cameras or accessories with rated currents exceeding 3 A, otherwise the Ronin-MX may become damaged.

## Mounting the Camera

The Ronin-MX uses an adjustable camera mounting plate that allows you to easily balance, install, and remove the camera. The Ronin-MX has been tested with the following types of cameras. Other cameras similar in size and weight may also be compatible.

### Supported Cameras

ARRI ALEXA Mini*	Canon 5D MK III	Panasonic GH3
Black Magic Cinema Camera*	Canon 6D	Panasonic GH4
Black Magic Pocket Cinema Camera	Canon 7D	RED EPIC*
Canon 1Dc	Canon C100	Sony Alpha 7 Series
Canon 5D MK II	Nikon D800	

\* Must be used with dedicated camera accessories. Visit the Official DJI Online Store to learn more.

### Camera Size Requirements

The maximum depth from the center of gravity on the camera base plate is 120 mm. The maximum height, measured from the top of the camera base plate, is 130 mm. The maximum width is 160 mm.



- Make sure the camera is powered off during installation.
- It is recommended to use soft connection cables to avoid obstructing camera movement.

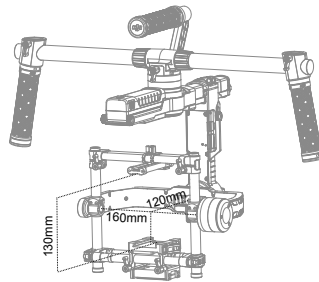

## How to mount the camera

1. Attach the camera mounting plate to your camera using the provided camera screws A, B, C or D. Choose the correct screw holes according to your camera's configuration. Some cameras have two tripod mounting holes. If two mounting holes are available on your camera, use them both. Secure the camera as firmly as possible.
2. Install the lens support by gently pushing it up, so that it is applying light pressure to the lens. Then tighten the thumbscrew.

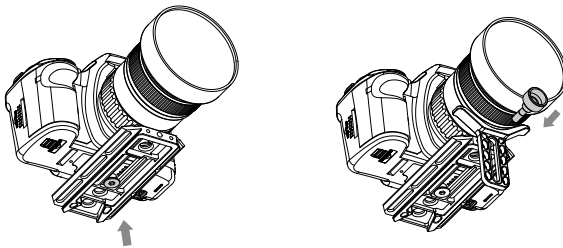

### NOTICE

- Camera screws A and B only fit the holes of the mounting plate, while camera screws C and D only fit the slot of the mounting plate. Be sure to use the correct 1/4" or 3/8" screws.
- The lens support can be installed facing outward or inward to accommodate different lens types.
- Ensure alignment of the camera mounting plate and then tighten the mounting screw before tightening the lens support.

### TIPS

Why do you need to use a lens support?

Certain cameras have a very tight lens securing system, and some cameras such as the Canon 5D MK II and MK III have very loose lens securing systems. The Ronin-MX balances the camera as one solid unit. If the mounted camera has a loose lens securing system, the lens support must be used. This is because a loose connection between the lens and the camera body may allow vibrations that travel through to the camera but not directly to the lens, resulting in the two masses shaking at different frequencies. The resulting oscillations will be transmitted to the IMU, causing the whole gimbal to shake. If the lens support fits, it's best to use it at all times.

3. Mount the Camera Upper Mounting Plate to the top of the camera through the hot shoe and then tighten the screws.

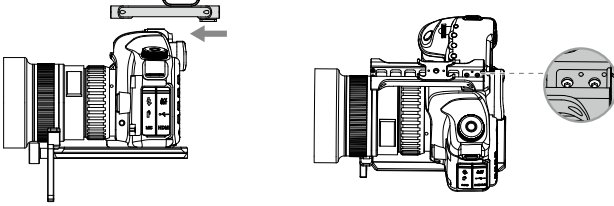

4. With the gimbal facing outward on the tuning stand, slide the mounting plate into the receiver until the safety lock engages. Adjust the vertical position of the crossbar to meet the camera upper mounting plate.
5. When the camera achieves a rough balance, tighten the camera base side clamp and the lock-knobs.

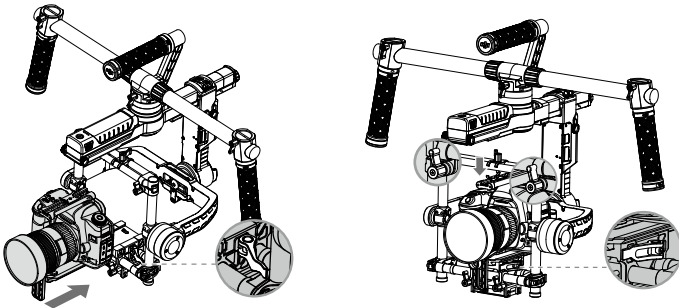

- You can adjust the tightness of the clamp with an M3 Allen wrench.
- The steps above are suitable for most cameras. When mounting a RED or ARRI camera, the proper camera accessories must be used.

6. You can also rotate the camera mounting plate 180 degrees to mount a camera upside-down when necessary in certain configurations.

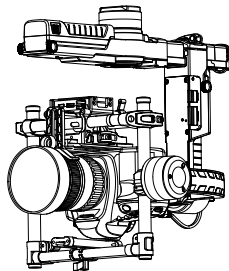

- When mounted on an aircraft, make sure the camera has a full, unobstructed range of motion when pointed down at 90 degrees. If the power distribution box prevents a full range of motion after it is balanced, try mounting the camera upside-down.



## Configuring the Handle Bar

The customizable handle bar on the Ronin-MX can be removed, if necessary. Loosen the two grip screws where the handle bar meets the gimbal and then remove the grips from the handle bar. You can remove one or both sides of the handle bar. The resulting configuration is shown below.

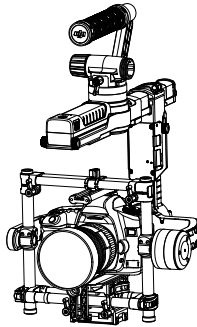

**TIPS** You may need to reduce the stiffness of the pan motor in this configuration.

## Balancing

To obtain the best performance from the Ronin-MX, proper balancing is a must. Accurate balance is critical for shots where the Ronin-MX will be subjected to extreme movements or accelerations (running, biking, moving cars, aircraft, etc.). Proper balance will also offer a longer battery runtime. There are three axes that need to be accurately balanced prior to turning on the Ronin-MX and setting up the software.

- NOTICE**
- The camera needs to be fully configured, with all accessories and cable connections, prior to installing and balancing the camera on the gimbal. If the camera has a lens cap, be sure to remove it prior to balancing.
  - Be sure that the Ronin-MX's power and camera are turned off while balancing the camera.

### Step 1: Balancing the Vertical Tilt

To adjust the vertical balance, you will need to change the camera's vertical position. Adjust the height of the crossbar to achieve vertical tilt balance.

1. Rotate the tilt axis so that the camera lens is pointing upward, then loosen the two vertical adjustment tabs and the lock-knobs on the top crossbar.
2. Gently slide the camera mount crossbar forwards or backwards until the camera points upwards when released.
3. Tighten the tabs and lock-knobs, then manually rotate the assembly, simulating tilt, to ensure there is no binding in the tilt motor. When proper balance is achieved, you can rotate the camera to any tilt angle and it will stay in that position (while holding the roll axis in position).

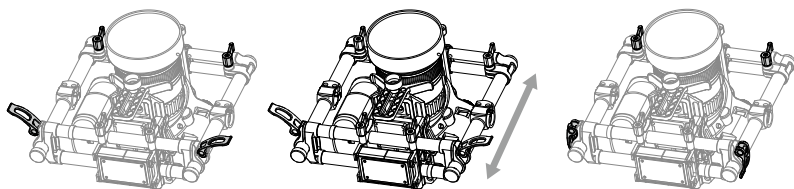

**NOTICE**

Ensure that the measurement marks match up on both of the vertical bars. If they do not match up, the assembly may be skewed higher or lower on one side which could cause the tilt motor to bind.

## Step 2: Balancing the Roll Axis

Balancing the camera from left to right on the roll axis is also required. When the proper left/right roll balance is achieved, the camera will remain level.

1. Loosen the three lock-knobs to allow the camera and mounting plate to slide left and right.
2. Slide the camera left or right until the roll axis remains level.
3. Tighten the three lock-knobs to lock the camera mounting plate in position.

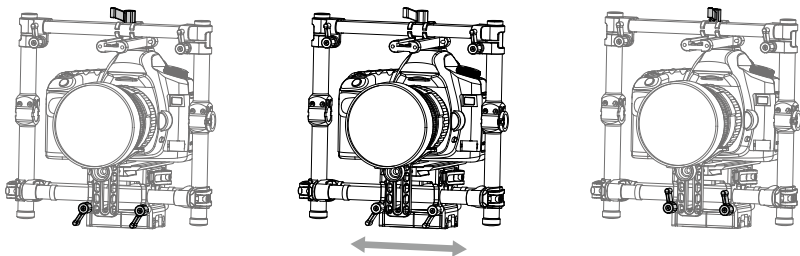

**NOTICE**

- When adjusting the roll balance position of the camera, only loosen the three lock-knobs a few turns to allow the camera base to slide. Do not loosen the lock-knobs excessively.
- The lock-knob can be pulled outwards and repositioned if there is an obstruction.

## Step 3: Balancing the Tilt Axis

1. Loosen the camera base's side clamp and the lock-knob on the center of the crossbar to allow the camera and mounting plate to slide forwards and backwards.
2. Slide the camera forwards or backwards until the tilt axis remains level. Only very small adjustments are required to achieve the proper balance.
3. Tighten the side clamp and the lock-knob to lock the camera and mounting plate in position. When the proper fore and aft tilt balance is achieved, the camera will stay level when you remove your hand (while holding the roll axis in position).

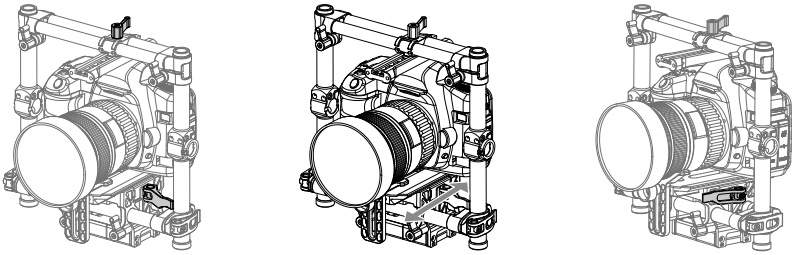

## Step 4: Balancing the Pan Axis

To balance the pan axis, you must adjust the pan axis slide.

1. Open the clamp [1] on the pan axis and turn the knob [2] to slide the assembly. Identify if the Ronin-MX is front heavy or rear heavy. Rotate the Ronin-MX on the stand so one side is higher than the other, if the front end rotates from the higher position to the lower position and that means the Ronin-MX is currently front heavy, then you will need to slide the gimbal backward, otherwise you need to slide the gimbal forward.
2. Tighten the clamp after balancing is completed. While the Ronin-MX is resting on the tuning stand, try rotating the Ronin-MX. If the camera does not swing, the pan axis is properly balanced.

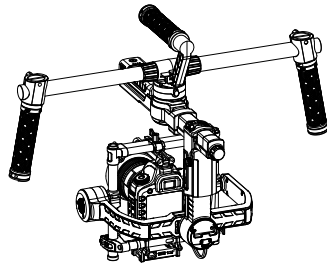
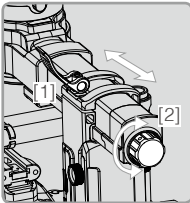

## Advanced Roll Adjustment

In cases where the camera itself is too light in comparison to the tilt motor assembly, advanced roll adjustment can be achieved by loosening the indicated screws and pushing the assembly to the right or left.

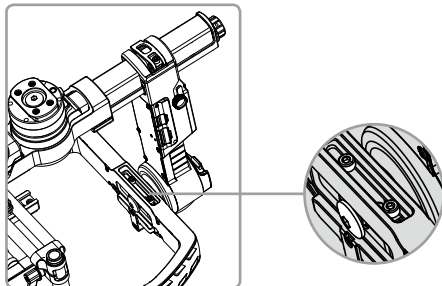

# Using the Ronin-MX on the Ground

## Tuning with the DJI Assistant (or DJI Ronin Assistant) App

After balancing the camera, you can adjust parameters in the DJI Assistant (for iOS) or DJI Ronin Assistant (for Android) app, and configure your Ronin-MX.

### Download and Install

1. Download the DJI Assistant app. For the iOS version, search “DJI Assistant” in the App Store, then follow the installation instructions. Search “DJI Ronin” in Google Play, then follow the installation instructions for the Android version.
2. Ensure that Bluetooth is enabled on your mobile device and orient the camera in the standard operating position (facing forwards). Turn on your Ronin-MX, then launch the DJI Assistant app.
3. When using the DJI Assistant app for the first time, you will be prompted to register using a valid e-mail address.
4. Connect your device to the Ronin-MX by following the step-by-step instructions in the DJI Assistant app. After connecting to the gimbal’s main control, you will see the Wizard menu. When the indicator at the top of the screen displays solid green and the blue light is blinking, the connection is complete. The green LED on the Ronin-MX will also light up.
5. Activation is required when using the Ronin-MX for the first time, otherwise the gimbal will not work. To activate your Ronin-MX, connect your mobile device to the Internet, then enter the “More” page in the DJI Assistant app and tap the “Activate” button.

#### TIPS

- After enabling Bluetooth on your mobile device, return to the DJI Assistant app to connect to the Ronin-MX. The Ronin-MX will not appear in the mobile device’s Bluetooth device list. It can only be connected via the DJI Assistant app.
- The functions in the iOS version and Android version of the DJI Assistant app are the same. DJI Assistant pages shown in this manual are from the iOS version.

### Basic Settings

The Wizard menu provides the most basic functions you may want to adjust upon receiving your Ronin-MX. These options are also the most frequently used functions during standard operation. You can adjust all of these settings in the Wizard menu.

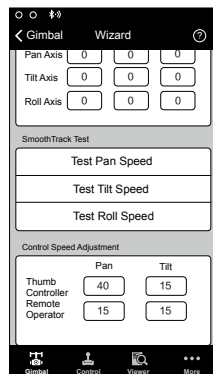
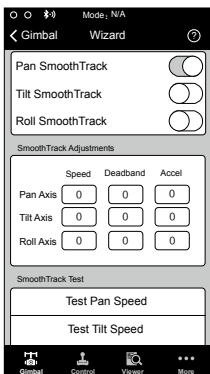
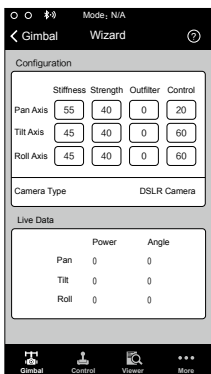

## 1. Camera Type

It is highly recommended to choose the Camera Type (DSLR Camera or RED Camera) to obtain the best Stiffness, Strength, Outfilter and Control value.

## 2. Live Data

This data represents the feedback from each motor axis. If a particular motor axis indicates a power reading greater than 10, this often means the mechanical balance of the camera hasn't been properly adjusted. A properly balanced camera rig will display readings close to 0 power on each axis, but these values may vary. The angle reading indicates the current angle of each axis in relation to the center.

## 3. Briefcase Mode

When Briefcase Mode is switched on, the Ronin-MX seamlessly transforms into a slim profile that can be held close to your body. With Briefcase Mode turned off, the Ronin-MX will allow the camera to roll when the Ronin-MX is tilted beyond the standard roll axis parameters.

## 4. SmoothTrack Mode

When SmoothTrack Mode is enabled, the Ronin-MX can be "steered", on the selected axis, by the camera's operator. The steering/translation speed can be adjusted for each axis independently. When the Ronin-MX's top bar is rotated left or right, the camera will move, smoothly following the user's input, and stop at the appropriate angle. In the SmoothTrack options menu, the settings for the pan axis, roll axis and the tilt axis can be independently adjusted.

The Speed will determine how fast the camera will travel while translating a pan/roll/tilt movement. The Deadband setting determines how much movement the gimbal will tolerate prior to translating the camera's pan/roll/tilt. The Acceleration setting determines how closely the camera will follow the translated pan/tilt/roll movement.



**TIPS** When mounting a heavy camera (such as a RED camera) on the Ronin-MX, the Acceleration setting should be adjusted properly. If there is too much acceleration, the camera might shake. If there is too little acceleration, the SmoothTrack speed of the gimbal might not reach maximum speed.

---

The SmoothTrack pan, roll, and tilt speed can be tested by tapping the Test button. To avoid damaging the camera, make sure nothing is obstructing the camera before testing.

## 5. Control Speed Adjustment

The Remote Controller speed can be adjusted here. This setting represents the maximum speed in the pan and tilt axis when the Remote Controller sticks are pushed all the way in any given direction.

## Advanced Settings

More advanced functions can be adjusted here to meet your needs.

### Gimbal Menu

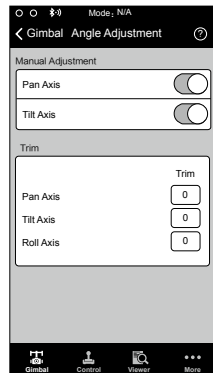
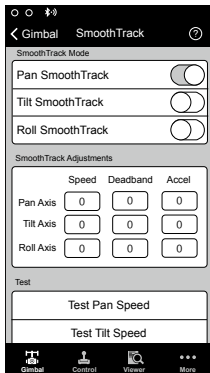
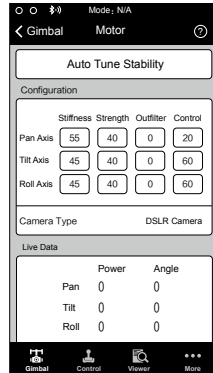
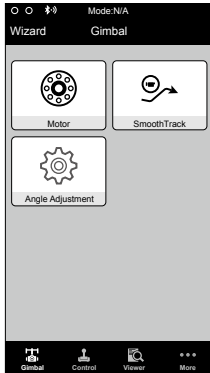

### 1. Motor Adjustment

It is highly recommended to choose the Camera Type (DSLR Camera or RED Camera) to obtain the best Stiffness, Strength, Outfilter and Control value.

Only tap the Auto Tune Stability button when the Ronin-MX performance is not good enough after choosing the Camera Type. The Auto Tune Stability allows for automatic adjustment of each motor's stiffness (as relayed from the sensors and interpreted by the Ronin-MX) to accomplish an optimized setting.

The motor stiffness adjustment allows the user to fine tune the amount of power that is applied by the motors as they react and balance the weight on each axis. The higher you adjust the stiffness settings, without causing any vibrations or oscillations on the gimbal, the better your experience will be.

Without causing any vibrations or oscillations, (1) Increasing the Strength value will reduce gimbal attitude errors; (2) If the gimbal experiences high frequency vibrations, increase the Outfilter value, otherwise it should be set to 0; (3) Increasing the Control value will compensate for angular vibrations.

Do not adjust the default Strength, Outfilter or Control values unless you are an advanced user.

## 2. SmoothTrack Mode

Refer to the Basic Settings section for details relating to SmoothTrack Mode.

## 3. Angle Adjustment

Enable Manual Adjustment to allow the pan and tilt axes to be adjusted by hand when the Ronin-MX is turned on.

The trim adjustment controls the amount of trim that is applied to each off-centered axis. The default setting for the center is 0°.

### Control Menu

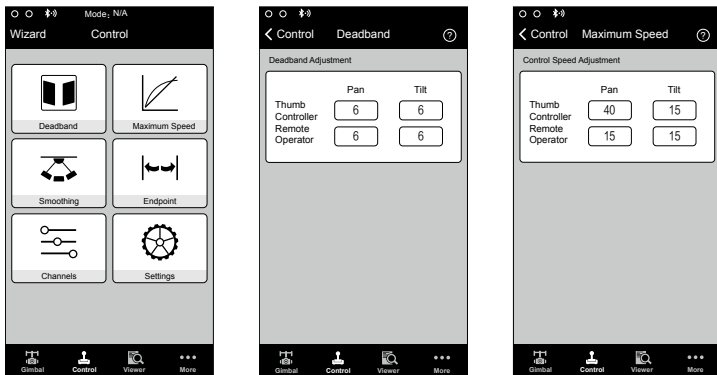

### 1. Deadband

The Thumb Controller and the remote operator controller can have independently adjusted pan and tilt deadband settings. The larger the deadband, the more stick movement will be required to translate into actual movement of the gimbal.

### 2. Maximum Speed

Maximum Speed is a function that prevents the control stick response from being a linear response, which is also known as an increasing response curve. This means the amount that the gimbal moves on the pan or tilt axis is not directly proportional to control stick manipulation. Control stick response can be adjusted to be milder below the first half of the control stick's travel and increased to a higher speed towards the last half of the control stick's travel. The preset exponential curve is calibrated based on maximum speed input.

The maximum speeds of the Thumb Controller and the Remote Controller sticks can be set independently of each other.

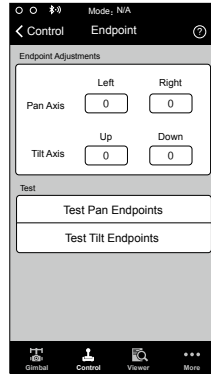
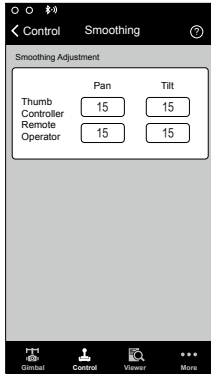

### 3. Smoothing

When the control stick input is released, the translated movement will be smoother and slower than if the smoothing is increased. If smoothing is set to 0, the slowdown will be translated as an abrupt stop. The Thumb Controller and remote operator control sticks can be set independently. Pan and tilt smoothing can also be independently adjusted.

### 4. Endpoint

Pan axis endpoint settings determine the farthest points to which the gimbal will rotate left or right during controller input. Pan axis endpoints can be adjusted independently, for left and right movement, when used with a Remote Controller or the Thumb Controller.

Tilt axis endpoint settings control the maximum points to which the gimbal can rotate up or down. Tilt axis endpoints can be adjusted independently for up and down movement when used with a Remote Controller or the Thumb Controller.

The pan and tilt endpoints can be tested. Ensure the camera is unobstructed before tapping the Test buttons.

---

**TIPS** The default endpoint settings for pan axis are set to 0, which means there are no endpoints for the pan axis so that the gimbal can rotate 360 degree continuously. If set to 0, the pan axis will not move when the "Test Pan Endpoints" button is pressed.

---

### 5. Channels

The channel indicator provides feedback during remote operator configuration. Pan, tilt, and roll can be re-assigned to either of the Remote Controller sticks. Each axis can also be reversed.

### 6. Settings

**Controller Priority:** If both input devices simultaneously send control signals to the gimbal, the input from the selected controller will take priority and will control the device at that given time.



Pan/Tilt Remote Speed Adjustment: Click to choose combined or independent settings.

Speed Toggle Presets: These presets will allow you to change the SmoothTrack speed remotely. If the Remote Controller is turned on, the Speed Toggle Presets for SmoothTrack will take precedence over the DJI Assistant settings. Once the Remote Controller is turned off, the SmoothTrack settings in DJI Assistant will take over.

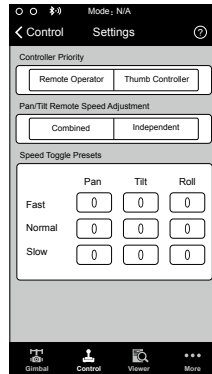
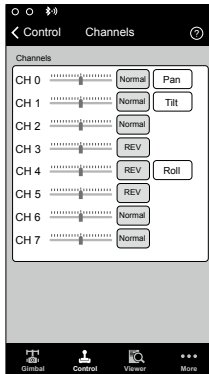

## Viewer Menu

The Viewer menu displays all essential data for live monitoring of the gimbal's electronics, as well as feedback from the motors. Power is indicated for each axis. The current angle of each axis is also indicated. The voltage of the battery, temperature of the main electronics, and also current uptime can also be monitored via this menu.

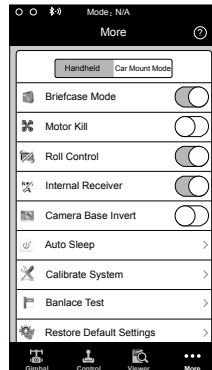
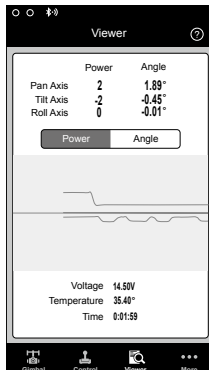

## More Menu

### Handheld/Car Mount Mode

Enable the Car Mount mode when using the Ronin-MX on a car or jib. When this mode is activated, the horizon will not drift when the car is making a turn at high speeds so that the footage will try to remain level with the car. Be sure the Ronin-MX is set to Underslung Mode when using on a car and ensure the gimbal is mounted perfectly level.

### Briefcase Mode

When Briefcase Mode is switched on, the Ronin-MX seamlessly transforms into a slim profile that can be held close to your body. With Briefcase Mode turned off, the Ronin-MX will allow the camera to roll when the Ronin-MX is tilted passed the standard roll axis parameters.

### Motor Kill

When the Motor Kill switch is activated, the Ronin-MX is still powered on, but the motors will be powered off. This will allow an adjustment to the gimbal or camera without having to turn it off completely. Prior to turning off the Motor Kill Switch, make sure the gimbal is positioned in the standard operating position. The Motor Kill Switch can also be used if the gimbal operator experiences an issue or needs to make a quick mechanical adjustment to the gimbal or camera setup.

### Roll Control

When the Roll Control is off, the roll axis movement cannot be controlled by a Remote Controller or the Thumb Controller.

### Internal Receiver

When the Internal Receiver is off, the gimbal cannot be controlled by a Remote Controller or the Thumb Controller, and can only be controlled by other devices via a D-Bus or Lightbridge connection.

### Camera Base Invert

Enable this function to invert the camera base to mount your camera upside-down. This is helpful when the Ronin-MX is mounted in Upright Mode on a vehicle, so that the captured footage will remain upright.

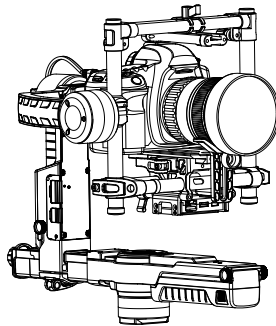

---

**CAUTION** The Camera Base Invert function must be enabled when the camera is mounted upside-down, otherwise the gimbal will automatically rotate to return to its normal position and hit the lens upon startup. This function is enabled by default.

---

## Auto Sleep

When Auto Sleep is enabled, adjust the Ronin-MX roll axis to 75 degrees or more (as shown below), and the gimbal will turn off without turning off the Intelligent Battery or other accessories. Recenter the tilt, pan and roll axes and position them horizontally to bring the gimbal back out of Sleep mode.

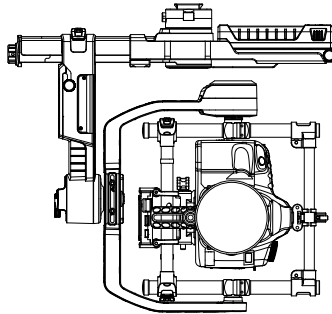

---

**CAUTION** Do not adjust the gimbal to the above position if Auto Sleep is disabled, otherwise the gimbal may become damaged.

---

## Calibrate System

Calibrate System is only used if you notice any kind of drift on any of the axes. To calibrate the system, place the Ronin-MX on the tuning stand and make sure it is completely steady. Be sure the camera can rotate 90 degrees with the lens pointing straight down, without any interference from video monitor wires. Then tap the Calibrate System button and let the process finish before picking up the Ronin-MX.

Do not touch or move the Ronin-MX during calibration.

## Balance Test

Tap to check the balance status of the tilt and roll axis. Ensure there are no obstacles present when running the Balance Test.

## Activation

Activation is required when using your Ronin-MX for the first time, otherwise the gimbal will not work. To activate your Ronin-MX, connect your mobile device to the Internet, then tap the "Activate" button.

## Restore Default Settings

This will restore all of the factory default settings that can be configured through the DJI Assistant app.

## Device List

To force the DJI Assistant app to find the Ronin-MX, open the "Device List" and the app will search for Bluetooth devices it recognizes.

## Tuning with the DJI Assistant Software for PC/MAC

You can also tune the Ronin-MX and upgrade the firmware through the DJI Assistant software for PC or MAC.

**NOTICE**

- The configuration settings in the DJI Assistant app and the DJI Assistant software for PC/MAC are automatically synced. There is no need to adjust the settings in both the mobile app and the desktop software.
- The DJI Assistant app and the DJI Assistant software for PC/MAC cannot be connected to the Ronin-MX at the same time. If running the mobile app, be sure to disconnect the Micro USB cable before using the desktop software.

## Installing the DJI Assistant Software for PC/MAC

Installing and Running on Windows

1. Download the DJI WIN DRIVER INSTALLER from the Ronin-MX product page on DJI.com. Connect the Ronin-MX to your PC via the provided USB cable and be sure the Ronin-MX is powered on prior to installing the DJI WIN DRIVER.
2. Download the appropriate Assistant installer from DJI.com.
3. Double click the Assistant installer and follow the steps to finish the installation.
4. Run the Assistant.
5. Upgrade the firmware or configure parameters using the Assistant as needed.

**TIPS**

The Assistant installer supports Windows XP or above.

Installing and Running on Mac OS X

1. Download the Assistant installer (.DMG) from the Ronin-MX product page on DJI.com.
2. Run the installer and follow the prompts to finish the installation.



3. If using Launchpad to launch DJI Assistant for the first time, Launchpad will block access because DJI Assistant has not been reviewed by Apple.

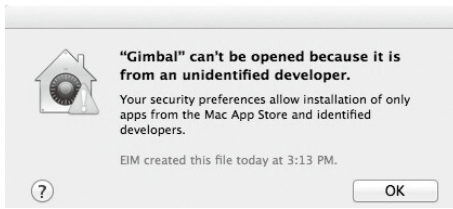

4. Locate the Gimbal app using Finder, then press “Control” and click the icon (or right-click the icon if using a mouse). Choose Open from the shortcut menu, then click Open in the dialog box to launch the program.
5. After successfully launching the program for the first time, double-click the Gimbal app icon, as usual, to launch the program using Finder or Launchpad.



TIPS

- The DMG installer supports Mac OS X 10.9 or above.
  - DJI Assistant on Mac OS X and Windows are the same. DJI Assistant pages shown in this manual are from the Windows version.
- 

## Settings

Adjust the parameters for the following functions before using the Ronin-MX: Camera Type, Briefcase Mode, SmoothTrack, and Maximum Speed Adjustment.

The definitions and functions of every button in the DJI Assistant app and the DJI Assistant software for PC/MAC are the same. Refer to the section describing the DJI Assistant app for more details.

## Basic

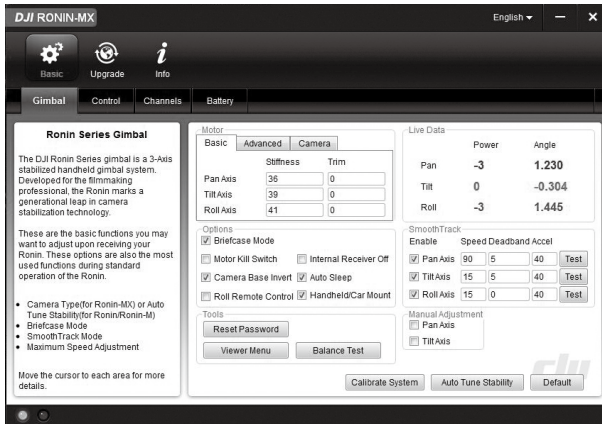

## 1. Gimbal

## Motor

**Basic:** Each axis has its own stiffness and trim adjustment.

**Advanced:** Allows you to adjust the Strength, Outfilter and Control values. Do not change the default values unless you are an advanced user.

**Camera:** Select the Camera type will obtain the best configuration for Stiffness Strength, Outfilter and Control values.

**Live Data:** This monitors the feedback from the motors on each axis.

**Briefcase Mode:** Select the checkbox to enable Briefcase Mode.

**Motor Kill Switch:** Select the checkbox to enable the Motor Kill Switch.

**Internal Receiver Off:** Select to prevent the gimbal from being controlled by the included Remote Controller or the optional Thumb Controller. The gimbal can then only be controlled by other devices via a D-Bus or Lightbridge connection when the Internal Receiver is off.

**Camera Base Invert:** Select the checkbox to allow the camera base to invert.

**Auto Sleep:** Select the checkbox to enable the Auto Sleep function.

**Roll Remote Control Off:** Select this checkbox to prevent the roll axis movement from being controlled by the included Remote Controller or the optional Thumb Controller.

**Handheld/Car Mount Mode:** Select Car Mount when using the Ronin-MX on a vehicle or jib.

**SmoothTrack:** Select this checkbox to enable SmoothTrack. Note that the pan axis and the tilt axis can be adjusted independently.

The pan and tilt SmoothTrack speed can be tested. Ensure that there is nothing obstructing the camera when running the test procedures.

**Reset Password:** If you forgot your Bluetooth connection password, click here to reset your password.

**Viewer Menu:** The Viewer menu provides essential live data for monitoring the Ronin-MX's electronics and feedback from the motors. Power is indicated for each axis. The current angle of each axis is also indicated.

**Balance Test:** Select the checkbox to check the balance status of the roll and tilt axis.

**Manual Adjustment:** Enable Manual Adjustment to allow the pan and tilt axes to be adjusted by hand when the Ronin-MX is turned on.

**Calibrate System:** Calibrate System is only used if you notice any kind of drift in any of the axes. To calibrate the system, place the Ronin-MX on the tuning stand and make sure it is completely steady.

Be sure the camera can rotate 90 degrees with the lens pointing straight down, without any interference from video monitor wires. Then click the Calibrate System button and let the process finish before picking up the Ronin-MX. Do not move the Ronin-MX during calibration.

**Auto Tune Stability:** The Auto Tune Stability button allows for automatic adjustment of each motor's stiffness settings (as relayed from the sensors and interpreted by the Ronin-MX).

**Default:** Click here to restore all settings to the factory defaults.

## 2. Control

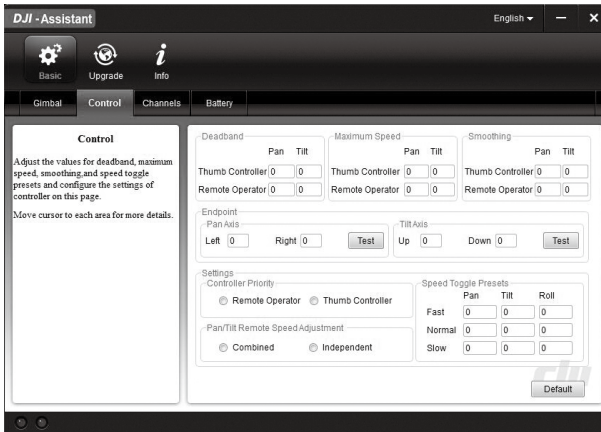

The Thumb Controller and the remote operator control sticks have a Deadband, Maximum Speed, and Smoothing adjustment, all of which can be set independently.

**Endpoint:** Pan axis endpoints can be adjusted independently for left and right movement when used with a Remote Controller or the Thumb Controller. Tilt axis endpoints can be adjusted independently for up and down movement when used with a Remote Controller or the Thumb Controller.

The pan and tilt endpoints can be tested. Ensure that the camera is unobstructed when clicking the test buttons.

**Controller Priority:** If both input devices simultaneously send control signals to the gimbal, the input from the selected controller will take priority and will control the device at that given time.

**Pan/Tilt Remote Speed Adjustment:** Click to choose combined or independent settings.

**Speed Toggle Presets:** These presets will allow you to change the SmoothTrack speed

remotely. If the Remote Controller is turned on, the Speed Toggle Presets for SmoothTrack will take precedence over the DJI Assistant settings. Once the Remote Controller is turned off, the SmoothTrack settings in DJI Assistant will take over.

### 3. Channels

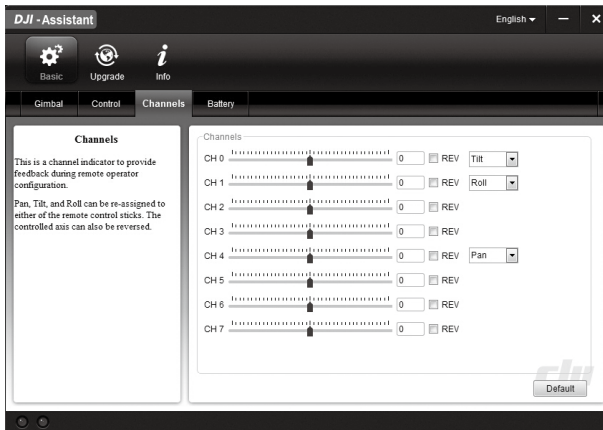

This is a channel indicator to provide feedback during remote operator configuration. Pan, tilt, and roll can be re-assigned to either of the Remote Controller sticks. The controlled axis can also be reversed.

### 4. Battery

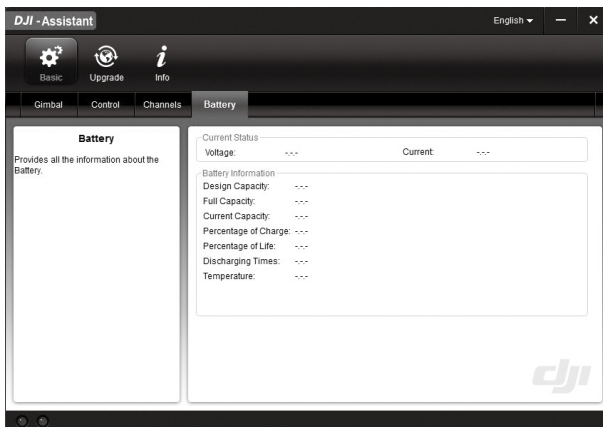

This page provides all of the essential information regarding the Ronin-MX's battery.



## Upgrade

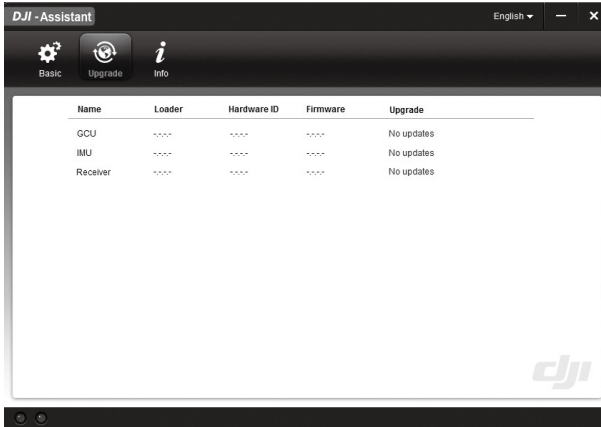

You can view the latest firmware version information on this page. Upgrade the firmware by following the steps below:

1. Connect the Ronin-MX to your computer via the Micro USB cable and wait until the indicator LED in the DJI Assistant blinks blue.
2. Click "Upgrade".
3. Wait for the download to finish.
4. Click "Upgrade" again and then click "Confirm".
5. Power the Ronin-MX off and then on after the upgrade is complete.

### TIPS

- Ensure that your computer is connected to the Internet.
- Close any antivirus programs and network firewalls.
- Ensure that the Ronin-MX is powered on during the upgrade. Do not power off the Ronin-MX until the upgrade is complete.
- Do not disconnect the USB cable during the upgrade.

## Info

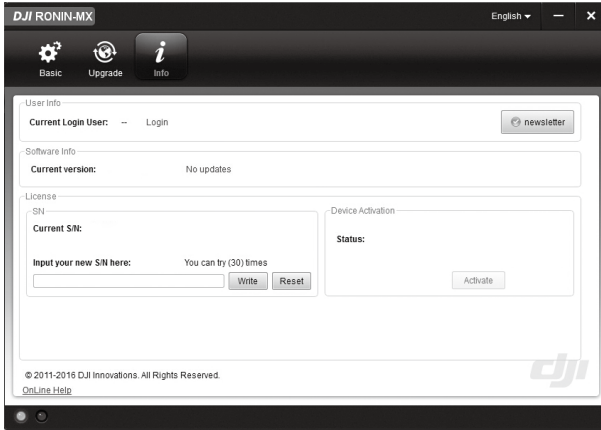

The Ronin-MX must be activated for first time use. Click the Activate button to activate your Ronin-MX, otherwise the gimbal will not work.

You can check which version of the DJI Assistant you are using in the Info tab. The S/N is a 32-digit authorization code that is used to activate certain functions. The authorization code for your unit is entered after it is manufactured. You may be asked to enter a new S/N after upgrading. Fill in the S/N and then click the Write button. If you enter an invalid S/N more than 30 times, the Ronin-MX will be locked and you will need to contact DJI Support.

## Remote Controller Operation

### Remote Controller Diagram

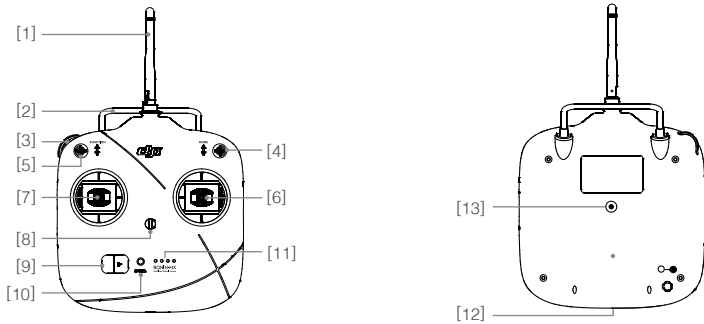

[1] Antenna

[2] Carrying Handle

[3] Left Dial (reserved)

[4] 3-Position Switch (MODE)

[5] 3-Position Switch (FUNCTION)

[6] Right Stick

[7] Left Stick

[8] Neck Strap Attachment

[9] Power Switch

[10] Power Indicator

[11] Battery Level Indicators

[12] Battery Charging & RC Assistant Port  
(Micro USB port)

[13] Reserved Port

### Connecting the Remote Controller to the Ronin-MX

1. Turn on the Ronin-MX.
2. Press the Bind Button (shown below) of the Ronin-MX once. The Ronin-MX's LED indicator will blink green quickly at that time.
3. Slide the power switch to the right to power on the Remote Controller. If the LED of gimbal turns solid green light, the Remote Controller and the Ronin-MX have been successfully bound.

The binding process only needs to be done once, unless the bind button is pressed or if the Ronin-MX needs to be bound to another Remote Controller.

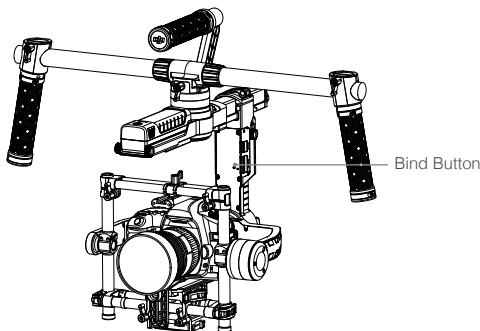







**TIPS**

- Make sure that the Remote Controller is sufficiently charged before use. If the low-battery alert sounds, please recharge the battery as soon as possible.
- Charge the Remote Controller's battery using the included Micro USB cable. Using the incorrect type of charging cable may cause damage.
- Turn off the Remote Controller before charging. The power LED indicator will glow solid green when the battery is fully charged.

**NOTICE**

When using the Remote Controller, ensure that the antenna is at least 20 cm away from any person.

### Remote Controller Power LED Indicator Status

Power LED Indicator	Sound	Remote Controller Status
 — Solid Green	None	Functioning normally or fully charged
 — Solid Red	None	Charging (Remote Controller is powered off)
 — Solid Yellow	None	Control stick calibration error, re-calibrate
 — Solid Red	BB--BB--BB	Low voltage warning
 ..... Quick Red flashing	BBBB.....	Critical low voltage warning
 ..... Slow Green flashing	B--B--B.....	Alert will sound after 15 minutes of inactivity. It will stop once you start using the Remote Controller.

























**TIPS**

The Remote Controller will turn off automatically when battery voltage is too low.







### Remote Controller Battery Level Indicator Status

The battery level indicator displays the current battery level. The following is a description of the indicators.

 : The LED is solidly lit     
  : The LED is blinking     
  : The LED is off

LED1	LED2	LED3	LED4	Current Battery Level
				75% to 100%
				50% to 75%
				25% to 50%
				12.5% to 25%
				0% to 12.5%
				<0%

## Remote Controller Features

	<p><b>MODE:</b> The MODE switch is used for toggling SmoothTrack.</p> <p>In Position 1 , SmoothTrack is off. The Remote Controller is free to control the pan axis and stops and holds the last position determined by the pan axis control stick.</p> <p>In Position 2 , SmoothTrack is on. The Remote Controller is free to control the pan axis and stops and holds the last position determined by the pan axis control stick.</p> <p>In Position 3 , SmoothTrack is on. The gimbal will reorient and reset the pan angle to the forward-facing direction when the pan axis control stick is released.</p>		
	<p><b>FUNCTION</b></p> <p>1. The FUNCTION switch is used to select the SmoothTrack speed. There are 3 possible selections: Fast, Normal, and Slow. The value of each speed can be preset in the DJI Assistant app or DJI Assistant software for PC/MAC.</p> <p>Position 1  -Fast    Position 2  -Normal    Position 3  -Slow</p> <p>2. Activating Motor Kill Switch Quickly flip the FUNCTION Switch between Position 1 and Position 3 at least three times to activate the Motor Kill Switch. Repeat this process to turn off the Motor Kill Switch. Be sure to position the camera in the standard operating position before re-activating the gimbal's motors. The Motor Kill Switch is useful if the gimbal operator runs into an issue or needs to make a quick mechanical adjustment to the gimbal or camera setup.</p>		
	<p><b>Left Stick (Default settings):</b> Horizontal movements on the left stick control the roll axis. Vertical movements have no definition.</p>		
	<p><b>Right Stick (Default settings):</b> Horizontal movements on the right stick control the pan axis.</p>		<p><b>Right Stick (Default settings):</b> Vertical movements on the right stick control the tilt axis.</p>

 **TIPS** These stick settings can be customized in the DJI Assistant app or the DJI Assistant software for PC/MAC.

## Operation Modes

The Ronin-MX has three operation modes: Underslung Mode, Upright Mode and Briefcase Mode.

### Underslung Mode

Underslung Mode is the standard, default mode. The Ronin-MX can be used in this mode without any adjustments.

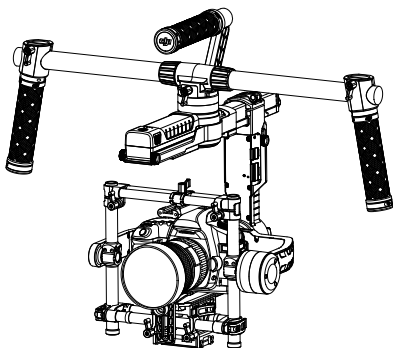

### Upright Mode

Flip the gimbal forward 180 degrees and it will automatically change to Upright Mode. Alternatively, you can change the gimbal into Upright Mode before turning it on. Upright Mode is ideal for car mounts or other top down perspective camera positions, as it allows you to shoot higher and/or at eye level. Upright Mode can also be used without any adjustments. Do not flip the gimbal sideways (left or right) to convert to Upright Mode.

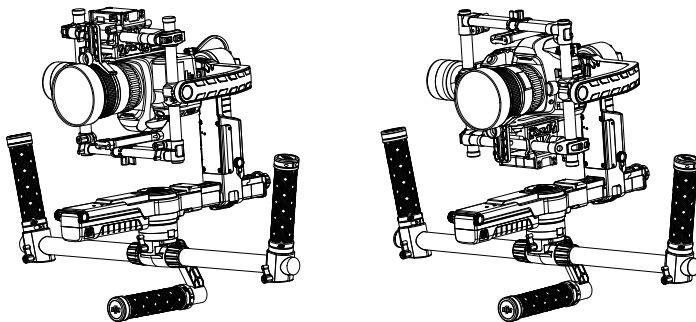

## Briefcase Mode

Briefcase Mode allows you to hold the Ronin-MX in a slim profile close to your body. To use Briefcase Mode, tilt the gimbal 90° to the left or right vertically on the roll axis. You can turn Briefcase Mode off in the DJI Assistant app, in which case the Ronin-MX will never automatically transform into Briefcase Mode. In Briefcase Mode, the Remote Controller cannot pan, tilt, or roll the gimbal.

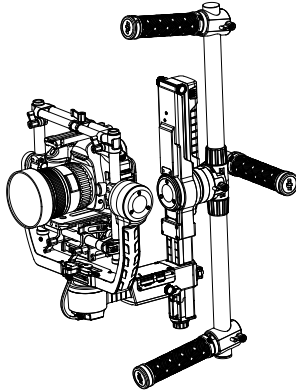

## Using with the Matrice 600

### Mounting the Ronin-MX onto the Matrice 600

Before mounting the Ronin-MX onto a Matrice 600, ensure the camera is mounted securely on the Ronin-MX and the balance is adjusted properly.

1. Remove the upper cover and lower cover from the Matrice 600's center frame and the expansion mounting kit.

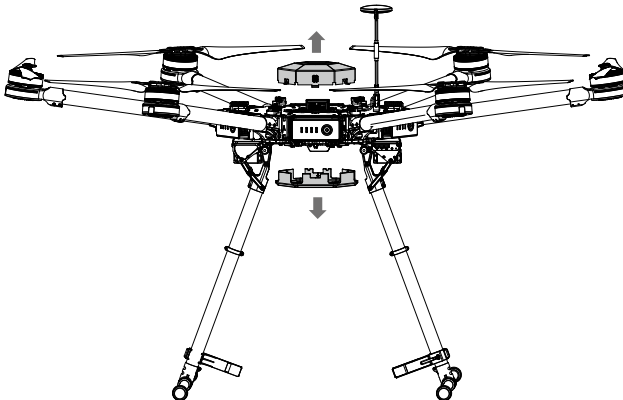

2. Connect one end of the provided CAN cable to the CAN1 port on the Matrice 600's main controller, and pull the other end through the outlet of the center frame. Then re-mount the Matrice 600's upper and lower covers.

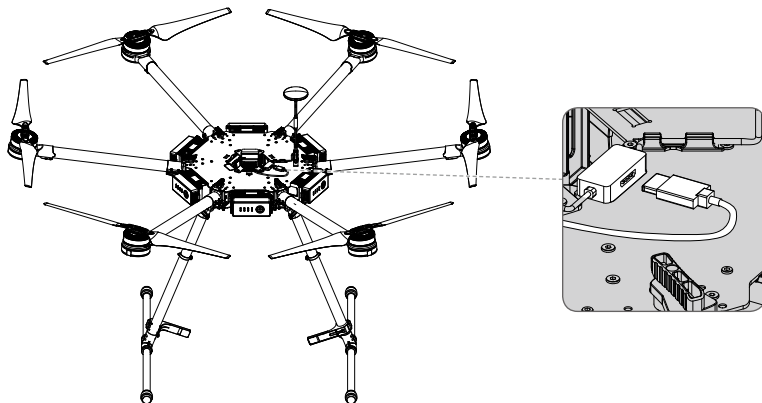

3. Adjust the Ronin-MX vibration absorption mounting plate, then tighten the screws on the connector.

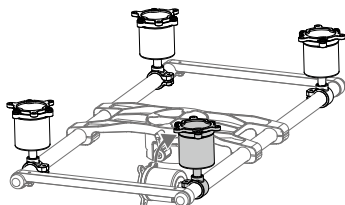

4. Mount the vibration absorber onto the bottom of the Matrice 600 with the lock-knob facing forward, then tighten the 12 vibration absorber screws provided.

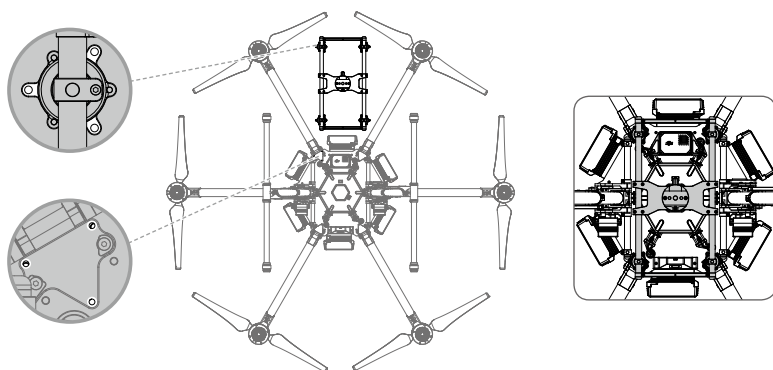



- Slide the gimbal into the gimbal connector of the vibration absorber, then tighten the lock-knob when you hear a "click", which indicates the lock has engaged.

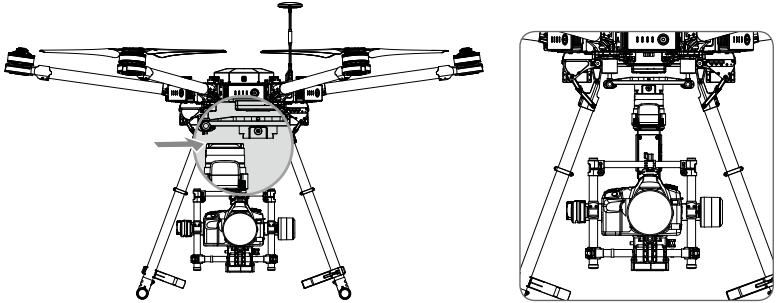

- Connect the CAN cable to the CAN2 port on the Ronin-MX.
- Use the DJI SRW-60G wireless video link to transmit HD images without obstructing the pan axis movements of the Ronin-MX. Refer to the SRW-60G User Manual for instructions.
- If not using the DJI SRW-60G, HD images can also be transmitted by connecting the DJI Lightbridge 2's Air System to the camera's HDMI port.

**WARNING**

- Be sure the Ronin-MX is mounted properly and firmly, and all the connections are correct and will not obstruct the Ronin-MX's movements.
- For users of the Matrice 600 and Ronin-MX in the United States, Federal Communications Commission (FCC) regulation prohibits the operation of unlicensed devices transmitting in the 57-64 GHz on aircraft or satellites. The SRW-60G operates on an unlicensed basis in the 57-64 GHz band.

**NOTICE**

Note that wire connections for the video link will obstruct the pan axis movement at certain angles. The pan axis cannot rotate 360 degrees continuously.

## DJI GO App Tuning

You can adjust software parameters and configure your Ronin-MX by using the DJI GO app. Launch DJI GO and then enter Camera view.

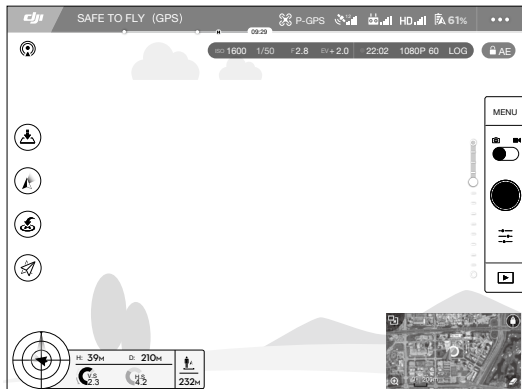

### Setting App Output Mode

Set the App Output Mode in the DJI GO app to display the image on your mobile device from the camera used with the Ronin-MX.

1. Tap **HD** and then Disable EXT Port.
2. Adjust the Bandwidth Allocation to ensure that the "HDMI" percentage is more than 0%.
3. Set the App Out Mode to HDMI.

### Gimbal Working Mode

Tap  to select a gimbal work mode: Follow Mode, FPV Mode and Free Mode.

**Follow Mode:** the angle between the gimbal's orientation and the aircraft's nose remains constant at all times. The pan, tilt and roll axes can be adjusted by the Remote Controller.

**FPV Mode:** The gimbal will synchronize with the movement of the aircraft to provide a first-person perspective flying experience.

**Free Mode:** The gimbal's pan axis is not aligned with the aircraft's nose. The pan, tilt and roll axes can be adjusted by the Remote Controller.

---

**TIPS** The pan axis of Ronin-MX will be only able to rotate within  $\pm 30$  degrees if the landing gear of the Matrice 600 is lowered.

---

### Gimbal Settings

Tap  >  to configure the gimbal.

---

**TIPS** The definition and function of every button in the DJI GO app and DJI Assistant app are the same, refer to the section describing the DJI Assistant app for more details.

---

## Camera Type

It is recommended to select the DSLR Camera or RED Camera according to the mounted camera to obtain optimized settings for the Stiffness, Strength, Outfilter and Control values. The default settings for the Strength, Outfilter and Control values are complicated and should not be adjusted unless you are an advanced user.

## Adjust Gimbal Roll

Tap to fine tune the gimbal's roll if you notice the roll axis is not level.

## SmoothTrack Settings

Deadband and the speed can be adjusted separately for pan and tilt axes.

## Remote Controller Settings

Deadband, Maximum Speed and the Smoothing can be adjusted separately for pan and tilt axis control.

## Endpoint Settings

The endpoints for the pan and tilt axes can be adjusted to limit the maximum left/right or up/down angles.

## Camera Base Invert

Tap to allow the camera mount on the gimbal to invert.

---

 When the camera is mounted upside-down, enable the Flip Image function by tapping **HD.ill > Flip Image** to obtain a proper image.

---

## Motor Kill

When the Motor Kill Switch is activated, the Ronin-MX is still powered on even though the motors are powered off. This allows you to adjust the gimbal or camera without having to turn it off completely. Prior to turning off the Motor Kill Switch, make sure the gimbal is positioned in the standard operating position.

---

 Do not activate Motor Kill during flight.

---

## Gimbal Calibration

Only calibrate the gimbal when the Ronin-MX's axes are drifting. Place the aircraft in a steady flat area before performing the calibration. The Ronin-MX will be powered off and powered on again automatically when calibration is complete. Observe the roll axis position and recalibrate as needed if the roll axis is off level. Ensure there is nothing obstructing the gimbal's movements during calibration.

## Balance Test

Tap to check the balance status of the tilt and roll axis. Ensure there is nothing obstructing the gimbal's movements.

## Default Settings

Tap to restore all the gimbal settings to the default settings.

## Remote Controller Operation

### Single Remote Controller

The Ronin-MX can be controlled completely by the Matrice 600's Remote Controller instead of the Ronin-MX's Remote Controller.

Adjust the Ronin-MX's tilt or pan by using the gimbal dial on the Remote Controller. (Configure the C1 and C2 buttons according to the on-screen instructions in DJI GO.)

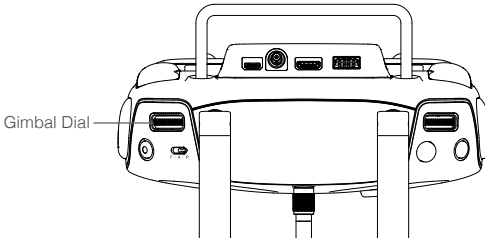

### Dual Remote Controller

The operation of the Master Remote Controller stays the same. Tap  to finish the "Remote Controller Settings" of the Slave Remote Controller according to the tips appearing in the DJI GO app.

## Adding a Third-Party Transmitter/Receiver

The Ronin-MX supports third-party transmitters/receivers, such as D-Bus. Connect the transmitter through the integrated port (refer to the Ronin-MX Diagram for the location of the D-Bus port).

## Maintenance

The figure below shows the proper configuration for transporting the Ronin-MX with the Tuning Stand. Using the hook-and-loop straps, lock the Ronin-MX in place, as shown. Be sure to remove the straps prior to turning the Ronin-MX on again.

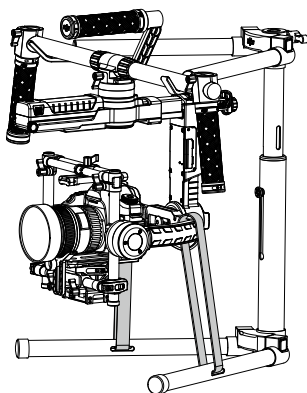

The Ronin-MX is a precise machine and is not waterproof. Keep it away from sand and dust when in use. After use, it is recommended that you wipe the Ronin-MX down with a soft dry cloth. Never spray any cleaning liquids onto the Ronin-MX.

# Troubleshooting

Problem	Solution
1 Motors appear to be weak	After balancing the camera, launch the DJI Assistant app or the DJI Assistant software for PC/MAC and select Camera Type.
2 The gimbal is vibrating, even after selecting the Camera Type	<ol style="list-style-type: none"><li>1) Check to make sure all knobs are tight, including the pan motor knob.</li><li>2) Check to make sure the camera screw is tight. Push on the camera plate to make sure it is not loose or sliding on the gimbal's camera mount.</li><li>3) Ensure the lens support has been mounted.</li><li>4) Try decreasing the stiffness setting of each axis. By looking at the "Power" readings for the axes, you should be able to tell if there is one particular axis being affected.</li><li>5) If the problem persists, try increasing the Outfilter value.</li></ol>
3 Ronin-MX seems to be drifting	Place the Ronin-MX on the Tuning Stand and enter the DJI Assistant app or the DJI Assistant software for PC/MAC. Tap/click the Calibrate System button and let the process finish before picking up the Ronin-MX.
4 SmoothTrack does not work	<ol style="list-style-type: none"><li>1) Turn on the Remote Controller and be sure that the MODE switch is not in Position 1 (the uppermost position).</li><li>2) Check whether SmoothTrack is turned off in the DJI Assistant app or the DJI Assistant software for PC/MAC.</li><li>3) Check whether the SmoothTrack deadband is turned up too high. If it is, reduce the Deadband value in the SmoothTrack Menu.</li></ol>
5 Motors appear to be weak suddenly after it works for a while	This may be caused by the high temperature of the motor. If an overheated motor is detected, the gimbal will enter protection mode. Turn off the gimbal for a while, then restart the gimbal after the motor cools down.
6 Forgot the Bluetooth password	Connect the Ronin-MX to the DJI Assistant software for PC/MAC and click the "Reset Password" button to reset the password.
7 Video footage appears to wobble from side-to-side or up-and-down	SmoothTrack speed is too high or SmoothTrack deadband is too low. Decrease the SmoothTrack speed or increase the Deadband value.

# Specifications

General	
Built-In Functions	<ul style="list-style-type: none"> <li>• Operation Modes</li> <li>    Underslung Mode</li> <li>    Upright Mode</li> <li>    Briefcase Mode</li> <li>    Aerial Mode</li> <li>    Jib or Wirecam Mode</li> <li>• Built-in, independent IMU module</li> <li>• DJI Specialized Gimbal Drive Motors with Encoders</li> </ul>
	<ul style="list-style-type: none"> <li>• Bluetooth Module</li> <li>• USB Connection</li> <li>• 2.4 GHz Receiver</li> <li>• Temperature Sensor</li> <li>• DJI Advanced 32-Bit DSP Processor</li> <li>• D-Bus Receiver Supported</li> </ul>
Peripheral	
Camera Tray Dimensions	Maximum depth from the center of gravity on camera base plate: 120 mm. Maximum height measured from top of the camera base plate: 130 mm. Maximum width: 160 mm
Accessory Power Connections	12V Regulated P-Tap x 2 USB 500 mW x 1 DJI Lightbridge x 1
GCU Input Power	Intelligent Battery: 423496-1580 mAh-14.4 V
Connections	2.4 GHz Remote Controller Bluetooth 4.0 USB 2.0
PC/MAC Assistant Requirements	Windows XP or above Mac OS X 10.9 or above
Mobile Assistant Software Requirements	iOS 7.1 or above Android 4.3 or above
Mechanical & Electrical Characteristics	
Working Current	<ul style="list-style-type: none"> <li>• Static current: 300 mA (@16 V)</li> <li>• Dynamic current: 600 mA (@16 V)</li> <li>• Locked motor current: Max 10 A (@16 V)</li> </ul>
Operating Temperature	5° to 122° F (-15° to 50° C)
Weight	Including handle bar: 6.11 lb (2.77 kg) Including vibration absorber: 4.74 lb (2.15 kg)
Dimensions	Excluding handle bar: 280 mm (W) x 370 mm (D)x 340 mm (H) Including handle bar: 560 mm (W) x 370 mm (D) x 440 mm (H)

**Working Performance**

Load Weight (Reference Value) 10 lb (4.5 kg)

Angular Vibration Range  $\pm 0.02^\circ$

Maximum Controlled Rotation Speed  
 Pan axis: 200°/s  
 Tilt axis: 100°/s  
 Roll axis: 30°/s

Mechanical Endpoint Range  
 Pan axis control: 360° continuous rotation  
 Tilt axis control: +270° to -150°  
 Roll axis control:  $\pm 110^\circ$

Controlled Rotation Range  
 Pan axis control: 360° continuous rotation  
 Tilt axis control: +45° to -135°  
 Roll axis control:  $\pm 25^\circ$

## Compliance Notice

**FCC Compliance Notice**

This device complies with Part 15 of the FCC Rules. Operation is subject to the following two conditions: (1) This device may not cause harmful interference, and (2) This device must accept any interference received, including interference that may cause undesired operation.

Any changes or modifications not expressly approved by the party responsible for compliance could void the user's authority to operate the equipment.

This equipment has been tested and found to comply with the limits for a Class B digital device, pursuant to part 15 of the FCC Rules. These limits are designed to provide reasonable protection against harmful interference in a residential installation. This equipment generates, uses and can radiate radio frequency energy and, if not installed and used in accordance with the instructions, may cause harmful interference to radio communications. However, there is no guarantee that interference will not occur in a particular installation. If this equipment does cause harmful interference to radio or television reception, which can be determined by turning the equipment off and on, the user is encouraged to try to correct the interference by one or more of the following measures:

- Reorient or relocate the receiving antenna.
- Increase the separation between the equipment and receiver.
- Connect the equipment into an outlet on a circuit different from that to which the receiver is connected.
- Consult the dealer or an experienced radio/TV technician for help.

**RF Exposure Information**

This equipment complies with FCC radiation exposure limits set forth for an uncontrolled environment. In order to avoid the possibility of exceeding the FCC radio frequency



exposure limits, human proximity to the antenna shall not be less than 20cm during normal operation.

## IC RSS Warning

This device complies with Industry Canada licence-exempt RSS standard (s). Operation is subject to the following two conditions: (1) this device may not cause interference, and (2) this device must accept any interference, including interference that may cause undesired operation of the device.

Le présent appareil est conforme aux CNR d'Industrie Canada applicables aux appareils radio exempts de licence.

L'exploitation est autorisée aux deux conditions suivantes:

- (1) l'appareil ne doit pas produire de brouillage, et
- (2) l'utilisateur de l'appareil doit accepter tout brouillage radioélectrique subi, même si le brouillage est susceptible d'en compromettre le fonctionnement.

IC Radiation Exposure Statement:

This equipment complies with IC RF radiation exposure limits set forth for an uncontrolled environment. This transmitter must not be co-located or operating in conjunction with any other antenna or transmitter.

This equipment should be installed and operated with minimum distance 20cm between the radiator & your body.

Any Changes or modifications not expressly approved by the party responsible for compliance could void the user's authority to operate the equipment.

## KCC Warning Message

"해당무선설비는 운용 중 전파혼신 가능성이 있으므로 인명안전과 관련된 서비스는 할 수 없습니다."  
 "해당 무선설비는 운용 중 전파혼신 가능성이 있음"

## NCC Warning Message

低功率電波輻射性電機管理辦法

第十二條 經型式認證合格之低功率射頻電機，非經許可，公司、商號或使用者均不得擅自變更頻率、加大功率或變更原設計之特性及功能。

第十四條 低功率射頻電機之使用不得影響飛航安全及干擾合法通信；經發現有干擾現象時，應改善至無干擾時方得繼續使用。前項合法通信，指依電信法規定作業之無線電通信。低功率射頻電機須忍受合法通信或工業、科學及醫療用電波輻射性電機設備之干擾。

EU Compliance Statement

SZ DJI TECHNOLOGY CO., LTD. hereby declares that this device is in compliance with the essential requirements and other relevant provisions of the R&TTE Directive.

A copy of the EU Declaration of Conformity is available online at [www.dji.com/euro-compliance](http://www.dji.com/euro-compliance)



EU contact address

DJI GmbH, Industrie Strasse. 12, 97618, Niederlauer, Germany

The content is subject to change.

Download the latest version from  
<http://www.dji.com/product/ronin-mx/info#downloads>



If you have any questions about this document, please contact DJI  
by sending a message to [DocSupport@dji.com](mailto:DocSupport@dji.com).

RONIN™ is a trademark of DJI. Copyright © 2016 DJI All Rights Reserved.