



# RADIOLINK AT9S

(DSSS&FHSS)

## INSTRUCTION MANUAL



RADIOLINK ELETRONIC LIMITED

Technical updates and additional programming examples available at: <http://www.radiolink.com.cn>

## INTRODUCTION

Thank you for purchasing Radiolink 2.4 GHz 12CH remote control system -- AT9S.

AT9S is default 9 channels transmitter, sells with receiver R9DS, you can upgrade AT9S to 12 channels only need by upgrade firmware. AT9S have to work with R12DS if choose 12 channels function(you can set in SYSTEM menu).

This system is extremely versatile, it is the most complete remote control device as so far in our product series, it can operate helicopter, fixed-wing, glider and multirotor. Radiolink, the first one who make DSSS and FHSS working synchronously come true, 16 channels pseudo random frequency hopping, QPSK modulation ensure excellent anti-interference performance, even can control stable in city center.

Despite the powerful function, humanized menu is designed applicable to both beginners and skilled person.

**Suggestion:** In order to fully enjoy the benefits of this remote control equipment and ensure flight safety, please read the instructions carefully and set up the device as described below, when we write the instruction to use the familiar and simple words to make it easy for beginners to understand the name and formulation.

Please refer to the manual or call our after-sales (+86-0755-88361717) or log in BBS (such as [www.rcgroups.com](http://www.rcgroups.com), <https://www.facebook.com/Radiolink-1455452961436694/>) to check the issues related answer to questions if you have any questions.

Due to unforeseen changes in production procedures, the information contained in this manual is subject to change without notice.

More information please check our website as below:

<http://www.radiolink.com>

Support and Service: It is recommended to have your Radiolink equipment serviced annually during your hobby's "off season" to ensure safe operation.

Please be sure to regularly visit the Service and Support web site at [www.radiolink.com](http://www.radiolink.com). This page includes extensive programming, use, set up and safety information.

Any technical updates and manual corrections will be available on this web pages.If you do not find the answers to your questions there, please see the end of our contact area for information on contacting us via email for the most rapid and convenient response.

FOR AFTER-SALES SERVICE:

Please start here for getting more service.

[www.radiolink.com](http://www.radiolink.com)

Phone:+86-755-88361717

Email:after\_service@radiolink.com.cn/after\_service1@radiolink.com.cn

FOR TECHNIQUE SUPPORT:

Please start here for answers to technique questions:

[www.radiolink.com](http://www.radiolink.com)

Phone:86-755-88361717

Email: alice@radiolink.com.cn

## **Note: About flying**

While you are getting ready to fly, if you place your transmitter on the ground, be sure that the wind won't tip it over. If it is knocked over, the throttle stick may be accidentally moved, causing the engine to speed up. Also, damage to your transmitter may occur.

Other than 2.4GHz system: Before taxiing, be sure to extend the transmitter antenna to its full length. A collapsed antenna will reduce your flying range and cause a loss of control. It is a good idea to avoid pointing the transmitter antenna directly at the model, since the signal is weakest in that direction.

In order to maintain complete control of your MULTIROTOR it is important that it remains visible at all times. Flying behind large objects such as buildings, grain bins, etc. is not suggested. Doing so may result in the reduction of the quality of the radio frequency link to the model.

2.4GHz system: DO not grasp the transmitter module's antenna during flight. Doing so may degrade the quality of the radio frequency transmission.

2.4GHz system: As with all radio frequency transmissions, the strongest area of signal transmission is from the sides of the 9CH transmitter module's antenna. As such, the antenna should not be pointed directly at the model. If your flying style creates this situation, easily move the antenna to correct this situation.

## **Warning!!!**

**This product is not a toy and is not suitable for children under the age of 18. Adults should keep the product out of the reach of children and exercise caution when operating this product in the presence of children.**

Please don't fly in the rain! Rain or moisture may enter the transmitter internal through gaps in the antenna or joystick flight and cause your flight to instability even out of control. If inevitable will fly in the wet weather (such as game), please be sure to use plastic bags or waterproof cloth to cover your transmitter, please don't flight if there is lightning.

This device complies with part 15 of the FCC Rules. Operation is subject to the following two conditions:

- (1) This device may not cause harmful interference, and
- (2) This device must accept any interference received, including interference that may cause undesired operation.

Any Changes or modifications not expressly approved by the party responsible for compliance could void the user's authority to operate the equipment.

# TABLE OF CONTENTS

<b>1</b>	<b>Part 1. INTRODUCTION OF AT9S SYSTEM.....</b>	<b>5</b>
1.1.1	Function of transmitter.....	5
1.1.2	Transmitter Panel Shows:.....	6
1.1.3	Receiver: R9DS.....	7
1.2	RADIO INSTALLATION.....	7
1.2.1	Guidelines to mount the servos, receiver and battery.....	7
1.2.2	Receiver and servo connections.....	9
1.2.3	Installment of antenna.....	11
1.3	RADIO BASIC SETTING.....	11
1.3.1	Basic setting of the transmitter.....	11
1.3.2	Model type.....	12
1.3.3	Bind.....	12
1.3.4	S.BUS.....	12
1.3.5	Transmitter Displays & Buttons.....	14
<b>2</b>	<b>PART 2. BASIC FUNCTION OF AIRPLANE.....</b>	<b>16</b>
2.1	QUICK GUIDE OF ACRO BASIC MENU.....	16
2.2	QUICK GUIDE: GETTING STARTED WITH A BASIC 4-CHANNEL AIRPLANE.....	17
2.3	AIRPLANE BASIC FUNCTION.....	18
2.3.1	Model Select.....	18
2.3.2	Model Type.....	20
2.3.3	End Point of servo travel adjustment (END POINT, also called EPA).....	21
2.3.4	Trim.....	22
2.3.5	SUB TRIM.....	23
2.3.6	Servo Reversing (REVERSE):.....	23
2.3.7	Dual/triple rates and exponential (D/R,EXP).....	24
2.3.8	Throttle Cut.....	27
2.3.9	IDLE DOWN (ACRO only).....	28
2.3.10	Fail Safe (F/S).....	29
2.3.11	Auxiliary Channel Function (including channel 9-10 controls).....	30
2.3.12	TIMER submenu (stopwatch functions):.....	31
2.3.13	TRAINER:.....	32
2.3.14	Logic Switch Selection (LOGIC SW):.....	33
2.3.15	SERVO display and cycle submenu:.....	33
2.3.16	TELEMETARY.....	34
<b>3</b>	<b>Part 3. ACRO ADVANCE MENU FUNCTIONS.....</b>	<b>36</b>
3.1	AIRPLANE WING TYPES (ACRO/GLID):.....	36
3.2	TWIN AILERON SERVOS (5-channel receiver, AILE-2 , ACRO/GLID).....	36
3.3	ACRO ADVANCE FUNCTION MENU.....	37
3.3.1	Program MIX.....	38
3.3.2	Curve Programmable Mixes (PROG.MIX5-8)(HELI: PROG.MIX5-6 ):.....	40
3.3.3	Flaperon (ACRO/GLID 1A+1F ):.....	42
3.3.4	FLAP-TRIM.....	43
3.3.5	AILE DIFF (ACRO/ GLID 2A+1F/ GLID 2A+2F).....	43
3.3.6	Air Break (ACRO/ GLID).....	44
3.3.7	ELEV-FLAP mixing (ACRO/GLID):.....	45
3.3.8	Dual Elevator Servos (with a rudder) (AILEVATOR) (ACRO):.....	46
3.3.9	Snap Rolls (ACRO).....	47
3.3.10	V-Tail (ACRO/ GLID).....	49
3.3.11	ELEVON.....	49
3.3.12	Gyro Sense.....	50
3.3.13	THR-DELAY (ACRO):.....	51
3.3.14	THR CURVE (ACRO).....	51

3.3.15	THROTTLE-NEEDLE mixing (ACRO/ HELI):.....	52
<b>4</b>	<b>PART 4 GLIDER MODEL FUNCTIONS.....</b>	<b>54</b>
4.1	SET BASIC MENU OF GLID.....	54
4.2	SET GLID TYPE.....	55
4.3	GLID ADVANCE MENU.....	56
4.3.1	AILE DIFF (FIND IN ACRO FUNCTION MENU 3.3.5).....	56
4.3.2	FLAPERON (GLID 1A+1F, FIND IN ACRO FUNCTION MENU 3.3.3).....	56
4.3.3	V-TAIL (FIND IN ACRO FUNCTION MENU 3.3.10).....	56
4.3.4	OFFSET (GLID 2A+2F):.....	56
4.3.5	START DELAY (GLID 1A+1F only):.....	57
4.3.6	CHAMBER-FLP.....	58
4.3.7	Camber Mixing:.....	59
4.3.8	BUTTERFLY (crow) mixing.....	60
4.3.9	AILE/ RUDD MIX.....	61
4.3.10	ELEV-FLAP mixing (see GLID menu 3.3.7).....	61
4.3.11	AILE-FLAP(GLID 2A+2F only):.....	61
4.3.12	SPOILER MIX (GLID):.....	62
4.3.13	FLAP-TRIM (see GLID 3.3.4).....	63
4.3.14	CONDITION.....	63
<b>5</b>	<b>Part. 5 HELICOPTER MODEL FUNCTIONS.....</b>	<b>64</b>
5.1	BASIC SETTING WITH HELICOPTER.....	64
5.2	HELI-SPECIFIC BASIC MENU FUNCTIONS.....	66
5.2.1	Swash Plate Types.....	67
5.2.2	SWASH AFR (not in SWH1):.....	67
5.3	HELI-SPECIFIC ADVANCE MENU FUNCTIONS.....	68
5.3.1	THR-CURVE and PIT-CURVE:.....	68
5.3.2	REVO MIX:.....	69
5.3.3	GYRO SENSE.....	71
5.3.4	THROTTLE HOLD.....	72
5.3.5	HOVERING ADJUSTMENTS (HOV-THR and HOV-PIT):.....	72
5.3.6	HIGH/LOW PITCH (HI/LO-PIT):.....	73
5.3.7	OFFSET.....	74
5.3.8	DELAY.....	75
5.3.9	GOVERNORS:.....	76
5.3.10	Throttle Mixing (THROTTLE MIX).....	77
5.3.11	SWASH-RING.....	78
5.3.12	THROTTLE NEEDLE (see ACRO MENU 3.3.15).....	78
5.3.13	PROG MIX (see ACRO MENU 3.3.1).....	78
5.3.14	CONDITION.....	78
<b>6</b>	<b>Part 6. MULTIROTOR FUNCTIONS.....</b>	<b>80</b>
6.1	MULTIROTOR BASIC MENU.....	81
6.1.1	MODEL TYPE.....	81
6.1.2	AUX Channel setting.....	82
6.2	ADVANCE MENU FOR MULTIROTOR.....	82
6.2.1	ATTITUDE.....	82
6.2.2	THROTTLE CURVE (see ACRO 3.3.14).....	82
6.2.3	PROG. MIX (see ACRO 3.3.1).....	82
	<b>AT9S Using Tutorials.....</b>	<b>83</b>

## Part 1 INTRODUCTION OF AT9S SYSTEM

Note that in the text of this manual, beginning at this point, any time we are using a feature's specialized name or abbreviation as seen on the screen of the AT9S, that name, feature, or abbreviation will be exactly as seen on the radio's screen, including capitalization and shown in a DIFFERENT TYPE STYLE for clarity. Any time we mention a specific control on the radio itself, such as moving SWITCH A, KNOB VR(B), or the THROTTLE STICK, those words will be displayed as they are here.

### 1.1 AT9S SYSTEM

#### 1.1.1 Function of transmitter

##### *Aero basic*

- V tail
- Elev-flap mix
- air brake
- Gyro mixing
- Twin Aileron Servos
- Twin Elevator Servos
- Snap roll

##### *Glider (3 wing model: 1A+1F/2A+2F/1A+2F)*

- V tail
- Elevon
- Offset
- 5 flight conditions (normal, start, speed, distance, landing)
- IDLE- DOWN (ACRO), THR-CUT (ACRO HELI) (engine shut off), and MOTOR CUT (GLID) setups to allow precise engine/motor control for taxi and landings.
- 15 model type memory
- New stick design with improved feel, adjustable length and tension.
- Triple rates available by setting dual rates to 3-position switches.
- Eight SWITCHES, 3 DIALS and 2 SLIDERS; completely assignable in most applications.
- Trainer system includes the "functional" (FUNC) setting, which allows the student to use the AT9S's mixing, helicopter, and other programming functions even with a 4-channel buddy box. (Optional trainer cord required.)
- AT9S transmitter features airplane friendly switch layout, with the trainer switch at the left hand (Mode 2), and a notched throttle to minimize throttle changes with rudder input. Defaults to ACRO model type.
- AT9S transmitter features helicopter-friendly switch layout, with idle-up and throttle hold switches at the left hand, and a smooth, ratchet-less (unsprung) throttle for perfect hovering. Defaults to HELI (H-1 swash plate type) model type
- Twin Ailerons
- Butterfly

##### *Helicopter (8 swashplate types, including CCPM)*

- 3 Idle Ups
- Revo. Mixing
- Delay
- Throttle and Pitch Curves per Condition
- Gyro Mixing including Separate Settings per Condition
- Governor Mixing

##### *MULTIROTOR:*

- ATTITUDE (Normal, attitude, GPS, hover, F/S, Aux)
- Throttle curve
- Mix programmable

1.1.2 Transmitter Panel Shows:

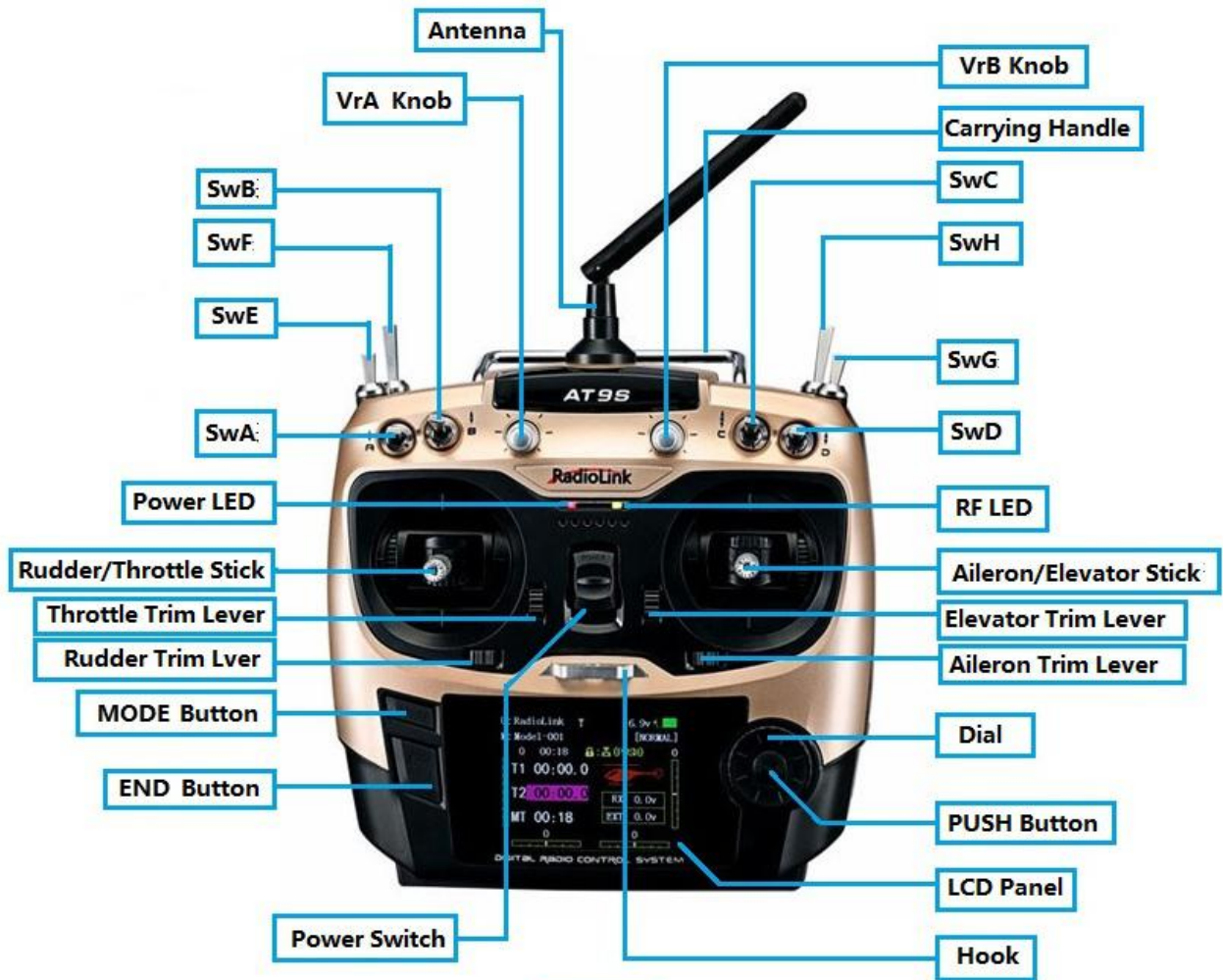

mode2



## SWITCH ASSIGNMENT TABLE

- The factory default functions activated by the switches and knobs for a AT9S transmitter are shown below.
- Most AT9S functions may be reassigned to non-default positions quickly and easily. Always check that you have the desired switch assignment for each function during set up.

Switch/Knob A or H	Airplane ( <b>ACRO</b> )	Sailplane/Glider ( <b>GLID</b> )	Helicopter ( <b>HELI</b> )	MULTIROTOR
<b>SWITCH A</b>	elevator dual rate ch10	elevator dual rate down=butterfly on ch10	elevator dual rate ch10	elevator dual rate ch10
<b>SWITCH B</b>	rudder dual rate ch9	rudder dual rate ch9	rudder dual rate ch9	rudder dual rate ch9
<b>SWITCH C</b>	up = <b>ELE-FLP</b> on center/down= <b>IDLE-DOWN</b> down = <b>AIRBRAKE</b> on	up = <b>ELE-FLP</b> on center = Distance cond. down = Landing cond.	governor	attitude
<b>SWITCH D</b>	aileron dual rate	aileron dual rate	aileron dual rate	aileron dual rate
<b>SWITCH E or G*</b>	Landing gear/ch5	---	Throttle hold/ch5	---
<b>SWITCH F or H*</b>	Snap roll /trainer	Trainer	Trainer/throttle cut	trainer
<b>SWITCH G or E*</b>	---	up = Speed cond.	idle-up 1 and 2	---
<b>SWITCH H or F*</b>	---	down = Start cond.	idle-up 3 /gyro	---
<b>KNOB A</b>	Flap/ch6 (flap trim if <b>FLAPERON</b> on)	Flap/ch6	<b>HOVERING PITCH</b>	ch 6
<b>KNOB B</b>	ch 8	ch 8	ch 8	ch 8
<b>KNOB C</b>	Spoiler/ch7 (disabled if <b>AIL-DIFF</b> on)	ch 7 (disabled if <b>AIL-DIF</b> on)	<b>HOVERING THROTTLE</b> ch7	ch 7
<b>SLIDER D</b>	---	ch 5	---	---

### 1.1.3 Receiver: R9DS

AT9S control system support R9DS.

Radiolink R9DS, 2.4G 9 channels receiver, DSSS and FHSS spread spectrum working synchronously. SBUS and PWM signal possible working at the same time.

## 1.2 RADIO INSTALLATION

### 1.2.1 Guidelines to mount the servos, receiver and battery

• Make certain the alignment tab on the battery, switch and servo connectors is orient correctly and 'key' into the corresponding notch in the receiver or connectors before plugging them in .When unplugging connectors, never pull on the wires. Always pull on the plastic connector instead.

• Receiver's Antenna: In generally receiver's antenna is longer than remote control, don't break or retract it, otherwise shorten the control distance. The antenna must be kept away from conductive materials, such as



metal. Please make distance test before flying.

- If your aileron servos are too far away to plug into the receiver, use an aileron extension cord to extend the length. Avoid plugging multiple extensions together to obtain your desired length. If the distance is greater than 50cm or high current draw servos are being used, use heavy servo extensions.

- Receiver Vibration and Waterproofing: the receiver contains precision electronic part. Be sure to avoid vibration, shock, and temperature extremes. For protection, wrap the receiver in foam rubber or other vibration-absorbing materials. It is also a good idea to waterproof the receiver by placing it in a plastic bag and securing the open end of the bag with a rubber band before wrapping it with foam rubber. If you accidentally get moisture or fuel inside the receiver, you may experience intermittent operation or a crash. If in doubt, please contact Radiolink aftercares or distributors for service.

- Always mount the servos with the supplied rubber grommets. Don't over tighten the screws. No part of the servo casing should contact the mounting rails, servo tray or any part of structure. Otherwise vibration will be transmitted to the servo causing damage of servo. Note the small numbers (1, 2, 3, and 4) molded into each arm on the servo arms. The number indicate how many degrees each arm is 'off' from 90 degrees to correct for minute manufacturing deviations from servo to servo.

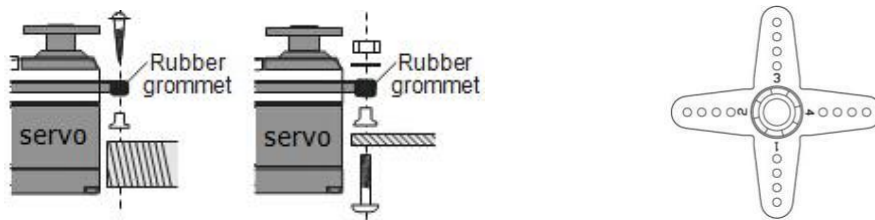

- To center the servos, connect them to receiver and turn on the transmitter and receiver. Center the trims on the transmitter, then find the arm that will be perpendicular to the pushrod when placed on the servo.



- After the servos are installed, operate each servo over its full travel and check that the pushrods and servo arms don't bind or contact each other. Also make sure the controls do not require excess force to operate. If there is an objectionable buzzing sound coming from a servo, there is probably too much resistance in the control. Find and correct the problem. Even if there is no servo damage, excess battery drain will result.

- Use the mounting plate from the receiver on/off switch as a template for the cutout and screw holes, mount the switch on the side of the fuselage opposite the engine exhaust, and where it won't be inadvertently turned on or off during handling or storage. Be certain the switch moves without restriction and 'snaps' from ON to OFF, and that the cutout allows full motion of the switch in both directions.

- When install the switch harness to the helicopter please use the switch cover. Generally sandwich the frame between the switch and switch cover and securely tighten the screws, Different models might require different installations. If so, please follow the model's instruction manual.

- To prevent the servo lead wires from being broken by vibration during flight, provide a slight amount of slack or extra so that the wire sticks out slightly and fasten it at suitable points. In addition, periodically check the wire during daily maintenance.

## 1.2.2 Receiver and servo connections

### (1) Airplane servo connection

Receiver output and channel	AIRPLANE
1	aileron-1 <sup>1</sup> /combined flap-2&aileron-1 <sup>1</sup>
2	elevator
3	throttle
4	rudder
5	spare/landing gear/aileron-2 <sup>1</sup> <sup>3</sup> /combined flap-1 and aileron-2 <sup>2</sup> <sup>3</sup>
6	spare/flaps/combined flap-1 and aileron-2 <sup>2</sup>
7	spare/aileron-2 <sup>1</sup>
8	spare/elevator-24/mixture control
9	spare
10	spare

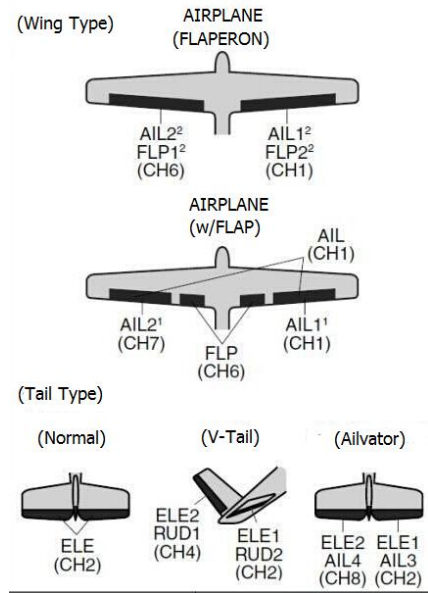

### (2) Glider/Sailplane servo connection

RX output & CH	Glider			
	GLID (1A+1 F)		GLID (2A+1F)	GLID (2A+2F)
	ELEVON	FLAPERON	AILE-DIFF	AILE-DIFF
1	Combined elev-2&aileron1 elev-1&aileron-2	Combined flap-2 &aileron-1	aileron-1	Aileron-1
2	Combined elev-1&aileron-2	Elevator/combined rudder-2&elev-1 <sup>1</sup>	Elevator/combined rudder-2&elev-1 <sup>1</sup>	Elevator/combined rudder-2&elev-1 <sup>1</sup>
3	spare/motor	spare / motor	spare / motor	spare/motor/splr-2 <sup>1</sup>
4	Rudder	Rudder/combined rudder-2&elev-2 <sup>2</sup>	Rudder/combined rudder-2&elev-2 <sup>2</sup>	rudder/combined rudder-1&elev-2 <sup>2</sup>
5	spare/splr-2 <sup>1</sup>	spare/spoiler-2 <sup>1</sup>	spare/spoiler-2 <sup>1</sup>	flap-2
6	Flaps	Combined flap-1&aileron-2	flaps	flap-1
7	Spare	spare	ailron-2	Aileron-2
8	spare/splr/splr-1 <sup>1</sup>	spare/splr/splr-1 <sup>1</sup>	spare/splr/splr-1 <sup>1</sup>	spare/splr/splr-1 <sup>1</sup>
9	Spare	spare	spare	spare
10	Spare	spare	spare	Spare

(Wing Type)

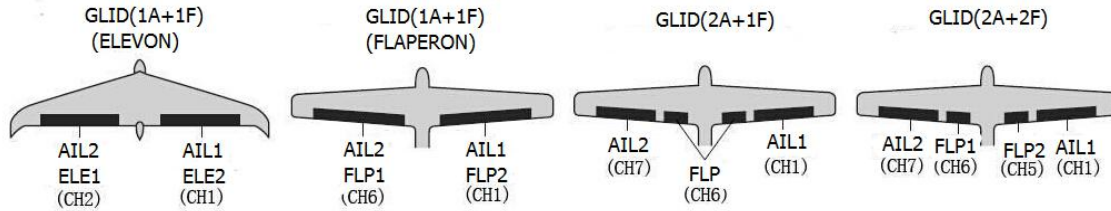

(Tail Type)

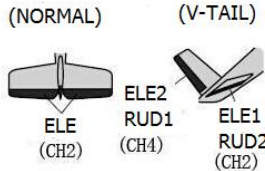

### (3) Helicopter servo connection

Receiver output and channel	Helicopter
1	aileron/cyclic roll
2	Elevator/cyclic pitch
3	Throttle
4	Rudder
5	Spare/gyro
6	Pitch(collective pitch)
7	Spare/governor
8	spare/mixture control
9	Spare
10	spare

(Swash Type)

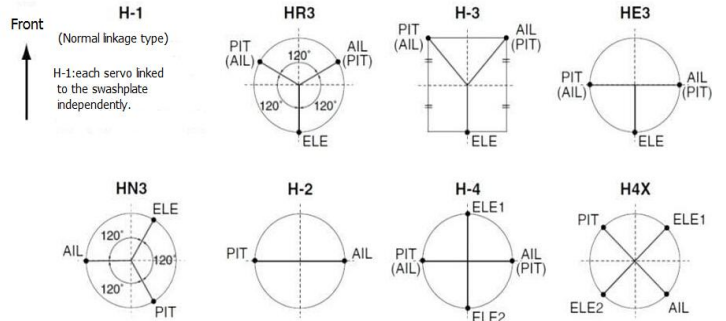

The above listed receiver and channels is referred to the channel 1~9 of the receiver R9DS, connect the receiver with the related servo, you can control the servos by the correspondent switch.

To be clear, the servo connected with the receiver channel 1 is controlled by the radio aileron lever; servo connected with channel 2 is controlled by elevator lever; servo connected with channel 3 is controlled by throttle stick; servo connected with channel 4 is controlled by the rudder lever. Channel 5~9 can be self-set with the related switches by the menu AUX-CH, and the sub menu. For channel 9, the LED indicator on the receiver flashes blue for S-BUS signal and red for PPM.

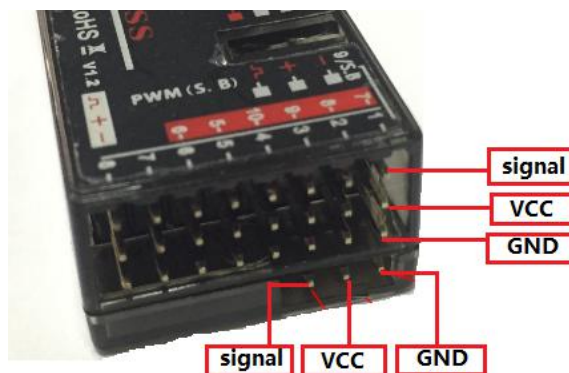



### 1.2.3 Installment of antenna

#### (1) Installment of receiver antenna



1. The antenna must be kept as straight as possible. Otherwise it will reduce the effective range.
2. Large model MULTIROTOR may of some metal part interfering signal; in this case the antennas should be placed at both sides of the model. Then the best RF signal condition is obtained at any flying attitude.
3. The antennas must be kept away from conductive materials, such as metal and carbon by at least a half inch. The coaxial part of the antennas does not need to follow these guidelines, but do not bend it in a small radius.
4. Keep the antennas away from the motor, ESC, and other noise sources as much as possible.
5. Press and hold the Easy Link (ID SET) one second, now the receiver starts work.
6. After all of the above steps finished, the LED indicator will turn and keep in red.

 The receiver can be packed by sponge or foam for shocking proof when it is installed to the model

 After all of the above steps finished, turn off the transmitter and then power it on, now the program functions to assure it under control of transmitter with a right connection

#### (2) Installment of transmitter

1. The transmitter antenna is adjustable so please make sure that the antenna is never pointed directly at the model when flying as this creates a weak signal for the receiver.
2. Keep the antenna perpendicular to the transmitter's face to create a better RF condition for the receiver. Of course this depends on how you hold the transmitter, but in most cases, adjusting the transmitter antenna so that it is perpendicular to the face will give the best results. Please adjust the transmitter antenna to the way you hold the transmitter.
3. Never grip the antenna when flying as this degrades RF quality.

## 1.3 RADIO BASIC SETTING

### 1.3.1 Basic setting of the transmitter

1. Display language: can be selected the display language of the function name, etc. in each function menu. The screen reads "LANGUAGE". Change this to the desired language.
2. Stick Mode: The screen reads "STK-MODE". Change this to the correct mode. Note that this will NOT change the throttle and elevator ratchets, etc. Those are mechanical changes that must be done by a service center.
3. RF Mode: the LED indicator will become solid green when RF Mode is active.
4. Adjusting Display Contrast: To adjust the display contrast, from the home menu press and hold the END BUTTON. Turn the DIAL while still holding the END BUTTON: clockwise to brighten and counterclockwise to darken the display.
5. User name setting: user name can be set by DIAL and PUSH with letters and numbers.
6. Alarming voltage:  
Transmitter: preset 8.6V, can be self-set  
Receiver: preset 4.0V, can be self-set  
Ext: preset 10.1V, can be self-set

### **1.3.2 Model type**

Under basic menu, use DIAL to select MODEL TYPE and enter by pressing PUSH. There are 6 different type included in the system, HELICOPTER, AEROBASIC, GLID(1A+1F), GLID(2A+1F), GLID(2A+2F), and MULTIROTOR, after model type is selected, press and hold PUSH for 1 second, when the word “are you sure to change” displayed, model type is changed.

### **1.3.3 Bind**

Each transmitter has an individually assigned, unique ID code. In order to start operation, the receiver must be linked with the ID code of the transmitter with which it is being paired. Once the link is made, the ID code is stored in the receiver and no further linking is necessary unless the receiver is to be used with another transmitter. When you purchase another R9DS, this procedure is necessary; otherwise the receiver will not work.

1. Place the transmitter and the receiver close to each other within 1 meters.
2. Turn on the transmitter, then power on the R9DS.
3. Connect CH3 of R9DS to ESC.
4. There is a black button on the R9DS, use a thin stick press the button twice in two seconds and release, receiver light start blinking, after about 8 times blinking, match code success when receiver signal LED always on!
5. Test with servo to make sure the binding is finished.

### **1.3.4 SBUS and PWM signal change:**

Short press the ID SET switch two times within 1 second, the signal is changed from normal PWM to SBUS. The red LED indicates the normal PWM and blue/purple LED indicates SBUS signal.

### **Two signal working mode:**

(1) PWM signal output working mode: red LED indicates PWM signal output, 9 channels Totally.

(2) SBUS signal output working mode: blue/purple LED indicates SBUS signal output, 10 channels totally. SBUS and PWM signal possible working at the same time with SBUS signal output working mode. CH9 output SBUS signal, the original CH1 to CH4 output CH7 to CH10 PWM signal at the same time.

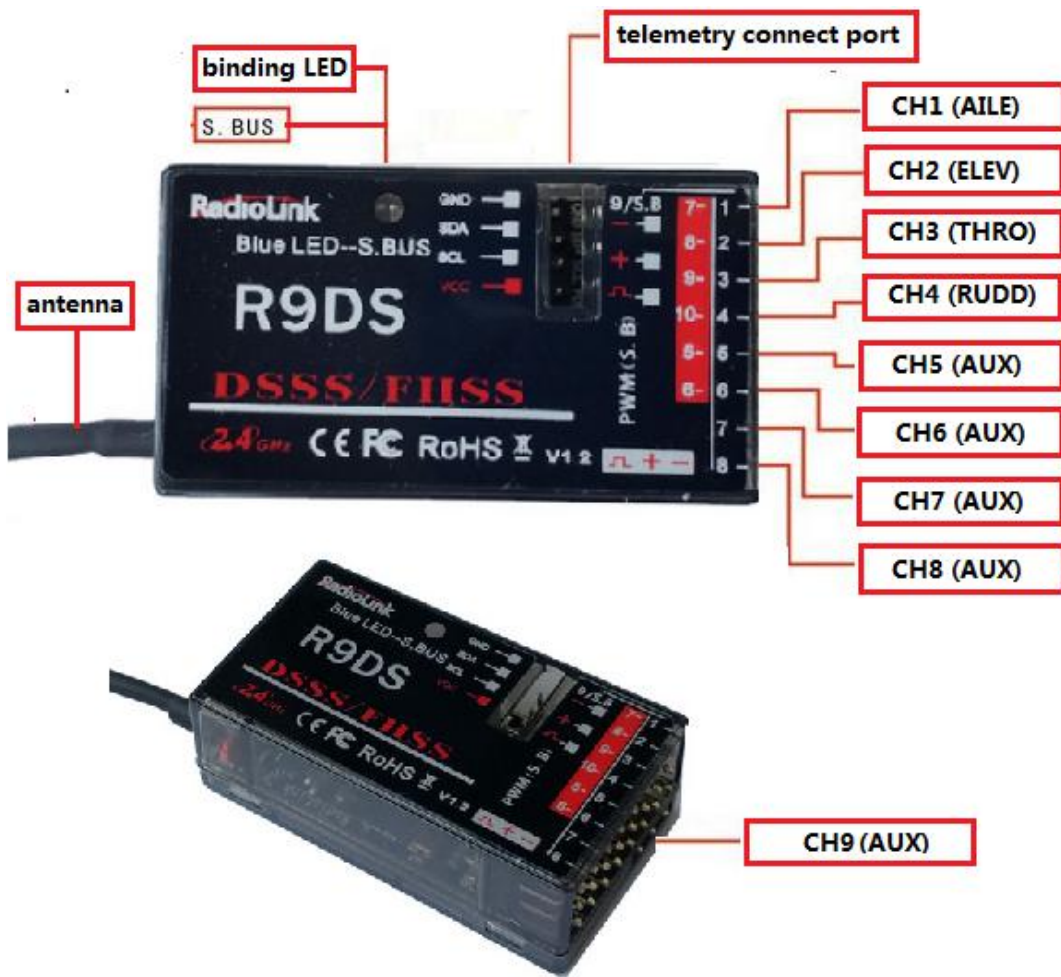

PWM signal working mode, 9 channels totally

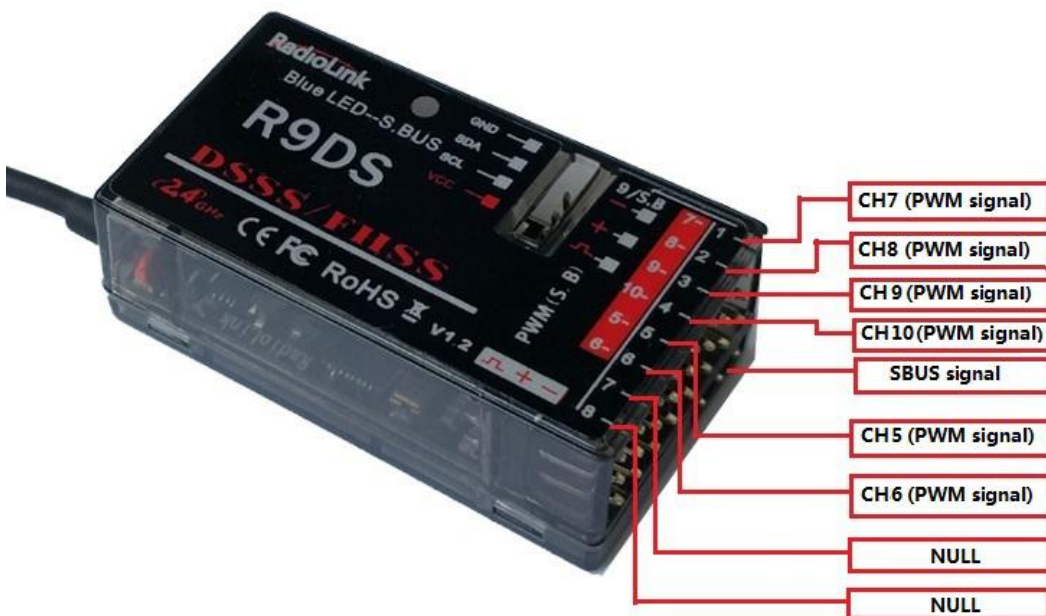

SBUS working mode( SBUS and PWM signal working simultaneous, 10 channels totally)

### 1.3.5 Transmitter Displays & Buttons

When you first turn on your transmitter, a confirmation double beep sounds, and the screen shown below appears. Before flying, or even starting the engine, be sure that the model type and name appearing on the display matches the model that you are about to fly! If you are in the wrong model memory, servos may be reversed, and travels and trims will be wrong, leading to an immediate crash.

#### Start-up screen

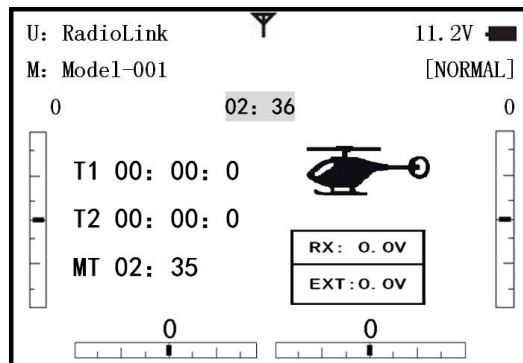

Total timer: Shows the cumulated ON times. (Hours: minutes)

T1/T2: T1/T2 timer display.(minutes: seconds)

MT: Model timer display Shows the cumulated ON time for each model.(hours: minutes)

#### Button instruction

MODE BUTTON:

Press and hold MODE BUTTON for one second to open programming menus. Press MODE BUTTON to switch between BASIC and ADVANCE. Press MODE BUTTON to scroll between conditions in certain functions.

END BUTTON:

Press END BUTTON to return to previous screen. Closes functions back to menus, closes menus to start-up screen.

PUSH BUTTON:

Press PUSH BUTTON to select a function.

Turn DIAL:

Turn DIAL clockwise or counterclockwise to scroll through choices within an option of a function

Warning and error display

When the transmitter is powered on, warning or error may happen by the following probability:

1. Battery low voltage alarming

Lithium battery 2S-4S can fit for the transmitter, warning voltage can be self-set according to different battery.

Setting step: power on the transmitter, press and hold MODE one second to enter basic menu, and press PUSH to enter PARAMETER. Choose TX ALARM by DIAL and PUSH to change relative data. Suggested min voltage is not less than 7.4V.

When the transmitter voltage is less than the setting voltage, it will beep till the transmitter is powered off. Most important thing is to land your model plane when the transmitter alarms.

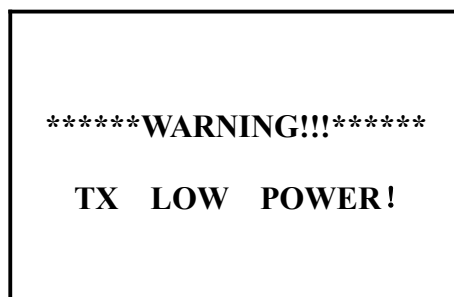

## 2. Mixing alarm

When the transmitter alarms mixing, it means at least one mixed switch is active. And when it is inactive, warning will stop then. When the transmitter is powered on, in different model type, mixing switch is shown as below:

ACRO: throttle cut, idle down, snap roll, air brake

GLID: butterfly, condition

HELI: throttle cut, throttle lock, speed up

If the warning continues even the related switch is set OFF, probably it is because some programs mixed by one switch and status OFF reversed. Now you need to set mixing alarm again by DIAL.



## PART 2. BASIC FUNCTION OF AIRPLANE





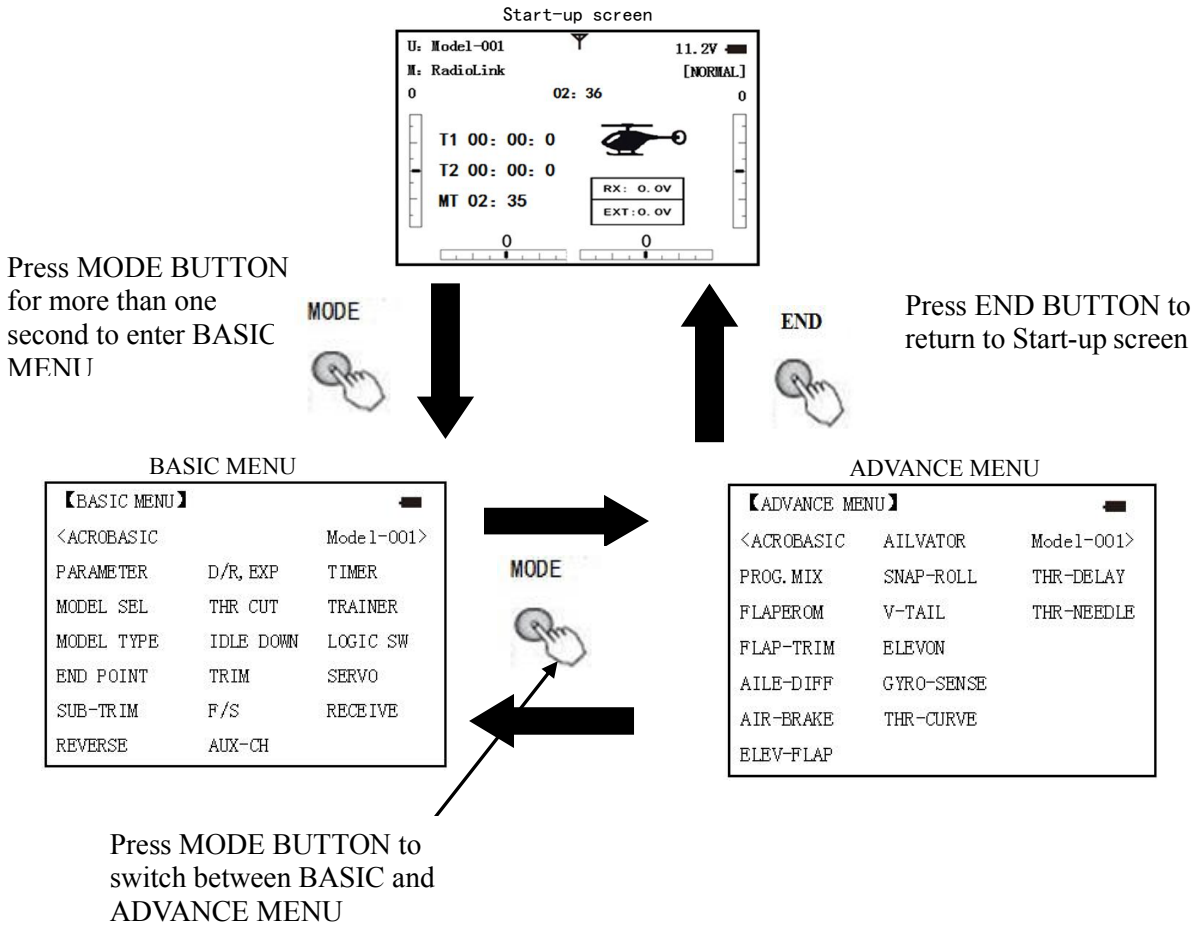









Please pay attention that the (BASIC) menu is suitable for all type models (airplane, helicopter, glider, multirotor). The motor cut will be introduced in Glider (Basic) Menu, except Idle down & Throttle cut. Helicopter Basic Menu include some extra function (swashplate tilting, throttle and pitch curves and the tail rotor anti torque mixing under normal flight model) will be discussed in Helicopter section.

### 2.1 A QUICK GUIDE OF ACRO BASIC MENU



 Turn DIAL clockwise or counterclockwise to scroll through choices within an option of a function.

 Press PUSH BUTTON to select a function.

- |  |  |  |
|--|--|--|
|  Mode Select        |  Switch Up        |  Stick Up          |
|  End Selection      |  Switch at Center |  Stick Right       |
|  Dial Left          |  Switch Down      |  Stick Down        |
|  Dial Right         |  Turn Knob Right  |  Stick Left        |
|  Dial Right or Left |  Turn Knob Left   |  Press Push Button |

## 2.2 A QUICK GUIDE: GETTING STARTED WITH A BASIC 4-CHANNEL AIRPLANE









































This guide is intended to help you acquainted with the radio, to give you some ideas and direction on how to do. We give you a big picture overview of what we accomplish; a ‘by name’ description of what we’re doing to help you with the radio; then a step-by-step instruction to leave out the mystery when setting up your model.

For additional details on each function, see that function’s section in this manual.

Goals of Example	Steps	Input for Example
Prepare your airplane	Install all servos, switched, receivers, etc. per your model’s instructions. Turn on transmitter then receiver; adjust all linkages so surfaces are nearly centered. Mechanically adjust all linkages as close as possible to proper control throws. Check servo direction. Make notes now of what you will need to change during programming.	
Name the model <i>(Note that you do not need to do anything to ‘save’ or store this data).</i>	Open the Basic menu, then open the PARAMETER	turn on the transmitter. MODE for 1 second to basic menu.  to choose model
	Go to Model Name	to Mode,  to Mode name, press PUSH to setting
	Input airplane’s name Close the Model sub-menu	To change first character, when proper character is displayed, push  to select.  To move to next character. Repeat as needed. END return to BASIC menu
Need to adjust END-POINT to meet with the related servo.	In the BASIC menu find the END POINT	to END POINT, press  to set
	Adjust end point (EX: THRO servo) Close the function	to Throttle  Throttle stick until carburetor closes as desired.  until throttle arm just open carburetor at fully throttle stick. Repeat for each channel as needed.

With digital trims you don’t shut the engine off with THROTTLE TRIM. Let’s set up IDLE-DOWN and ‘throttle cut’

Goals of Example	Steps	Input for Example
Idle down setting: Idle down is to lower the engine speed for landing, snap rolling acrobatic display, and launching etc. It is preset OFF and mainly used to start engine and glide, then to avoid flameout.	From the BASIC menu choose IDLE DOWN.	to IDLE DOWN, press
	Activate and adjust IDLE DOWN	to MIX, press ,  to ON, press C to center position, screen now reads ON. to RATE, to increase rate until engine idles reliably but low enough to sit still.
	Optional: change switch C command	to POSI, press ,  as you desired press
	Close the function	END BASIC menu, END again to startup screen.

THR CUT shuts the engine off completely with the flip of a switch.(Note: Do Not assign IDLE DOWN and THR CUT to both position of a 2 position switch	From BASIC menu, choose THR CUT	 to THR CUT,press 
	Activate, assign SWITCH and adjust. Close the function	 to MIX, press  ,  to INH  to SW, press  ,  to SwC  to POSI, press  ,  to DOWN  to RATE, press  ,  to down position,  throttle stick down  until the throttle barrel closed
Set up dual/triple rates and exponential (D/P,EXP) (Note that in the middle of the left side of the screen is the name of the channel and the switch position you are adjusting. D/R may be set per channel by choosing the desired switch and mix rate.	From BASIC menu, choose the D/R,EXP	 to D/R,EXP, press 
	Choose the desired control, and set the first (EX: high) rate throws and exponential.	 SwA to up position A  to CH, press  ,  to choose CH2, press   to D/R  Stick down, press  ,  to set, press   Stick up, press  ,  to set, press   to EXP  Stick up, press  to set, press   Stick up, press,  to set, press 
	Set the second(low)rate throws and exponential.	SwA  to down position  to D/R Repeat steps above to set low rate.

## 2.3 AIRPLANE BASIC FUNCTION

### 2.3.1 Model Select

Model submenu: includes three function that manage model memory: MODEL SELECT, MODEL COPY and MODEL NAME. Since these functions are related, and all basic features are used with most models, they are together in the Model submenu.

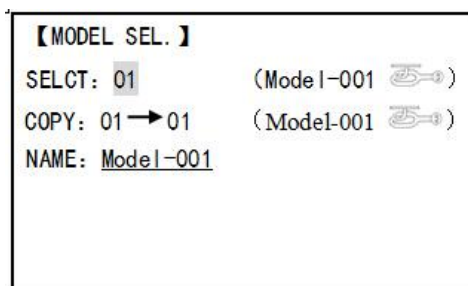

## MODEL SELECT

Totally there are 15 models stored in the system, followed by model name and plane type to use on tap, thus you don't need to set every time for different plane. MODEL NAME, MODEL TYPE and transmitter voltage. Make sure that MODEL TYPE is accomplished with your plane type before flight. Or it will cause error in servo and rudder.

## COPY

Save the present data as another model type, it will be displayed by shadow area to differ from. When this copy start, the object data will be fully covered including name, type and module type, and cannot recover.

⚠ Caution: when you save the present model type as another, all related data will be copied including the original model name. Accordingly, if you want to change the model type, the whole data need to reset, also for model name. The first thing to copy is to change the model type or delete the original name and rename a new model to avoid confusion.

## Model Name

This is used to set the present model name. Name all model to identify each other, and fast select the model type and reduce possible crash by wrong model type using.

Format to name a model:

- the name can be more than 9 characters
- every character can be letter, number, blank or special characters
- factory setting name MODEL-XXXX will be shown as (example model 1 display MODEL-0001)

Goals	Steps	Inputs
Name model3"Cap-232_"(where underline represents a blank space	Open Model	for 1second.(If ADVANCE,  again) to MODEL SEL. Press PUSH
	Confirm correct model (Ex:3)	If select doesn't show '3',perform Model select
	Go to Name to change the first character(Ex: M to C)	M to C, press PUSH.
	Change the next character	to choose character, press PUSH to
	Repeat the prior steps until finish naming model.	to a .Repeat.
	Close	

Sub-menu select: All parameters need one time setting. After the model type selected, you need to set the related data for it.

- what is the model type
  - whether the throttle channel 3 is right for the selected model type? Or you need to make sure channel 3 is of full range adjustable (glider only). Also to different model, you can set by throttle reverse correspondingly.
- Initialize the original data first, and set new data for the selected model type

**Model reset:** model reset is available in factory only. If you want to delete a new set model type, you need to delete one by one.

Goals	Steps	Inputs
Reset model memory 1	Confirm you're currently using the proper model memory(Ex:1)	On home screen, check model name and No. on top left, if not correct use Model Select.
	Open PARAMETER submenu	For 1second  to Model SEL, Push.
	Reset the memory	Push,  to Model 1,PUSH
	Confirm the change	Are you sure? Press PUSH
	Close	

## Model type select

- ACRO basic:

Drive ACRO basic type (multi airfoil. Detail in Twin Aileron Servos, Twin Elevator Servos, ELEV-FLAP mix and V-tail)

- glider:

Different tail type (detail in glider type)

- helicopter:

8 swash plate types (detail in helicopter type)

- Caution: decide a model type for the model plane. To most fixed wing plane, aero basic is better, because it has some function glider doesn't have. While sometimes, glider (2A+1F) is better.

- functions specially for aero basic:

- snap roll

- ELEV-flap mix (twin Elevator Servos support)

- oil power plane: idle down、throttle shut、throttle needle mix etc.

- functions aero basic doesn't have:

- 5 individual flight conditions (normal, start, speed, distance, landing)

If the model type selected for glider or helicopter, please go to the related chapter for setting. After model type changed, all parameters need to reset, including name.

## 2.3.2 Model Type

### Data reset

All set data can be reset to factory setting. This function will not delete all model type set in the radio.

#### Setup step:

Enter the basic menu for MODEL TYPE, use dial to choose a proper type and press PUSH for one second, when the screen displays "are you sure", press PUSH and the radio will beep, and it is set to factory data.



Caution: don't power the radio off before setting is finished, or the setting is invalid.

## Model Select

Goals	Steps	Inputs
Select proper Model Type for your mode l(Ex: ACRO)	Open BASIC menu, then PARAMETER submenu	Turn on the transmitter. MODE for 1s.(If ADVANCE, Mode again.
	Go to MODEL TYPE.	⊙to Mode TYPE, press PUSH.
	Select proper type Ex: ACRO Confirm the change. Close.	⊙to ACRBASIC,PUSH for 1s. "Are you sure" display. PUSH to confirm. End to BASIC menu.

Second aileron :( AILE-2) (ACROGLID1A+1FGLID2A+1F only): change the default choice for dual aileron servos from channels 6(FLAPERON) to channels 5 and 6, or channel 3 and 6, or channel 7(AIL-DIF) to channels 5 and 7. This allows you to utilize these 2 great functions while utilizing 5-channel receiver.

- Caution: Changing AILE-2 only tells the system which servos to utilize if FLAPERON or AIL-DIF is activated. You still must activate that function and complete its setup for details on twin aileron servos, including using AILE-2.

(Only for glider 1A+1F) if the channel 3 is set as the second aileron, the receiver F/S will become invalid.

### Adjustable travel limit (ATL)

Make the channel 3 TRIM LEVER (THROTTLE TRIM) effective only at low throttle, and disabling the trim at high throttle. This prevents pushrod jamming due to idling trim changes. This function defaults to ON. If you are not using channel 3 for throttle, you may want trim operation the same as on all other channels. To do so, set ATL to OFF. If you need the ATL to be effective at the top of the stick instead of the bottom, reverse the THR-REV setting. Note that this affects all models in the radio, not just the model you are currently editing.

Goals	Steps	Inputs
Change ATL from ON to OFF for battling robots, tanks, airbrakes and other channel 3 uses.	Open Basic menu, then to Mode Type.	Mode for 1s (If ADVANCE, Mode again).  To Mode TYPE, press PUSH.
	Go to ATL and change. (Ex: to OFF)	to ATL,  to OFF.
	Close	

### Home screen display

As shown below, home screen will display plane type and throttle pitch:

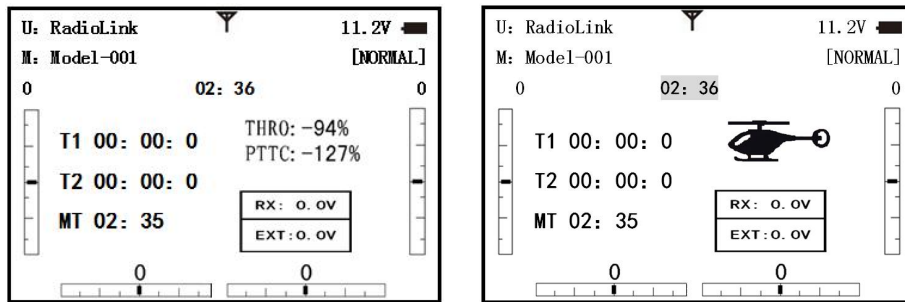

ILLUST: displays the illustration of helicopter in the home screen. (Default)

THR/PIT: displays the current throttle and pitch position in the home screen.

Step to change plane type image to THR/PIT: under model type helicopter, enter basic menu, choose MODEL TYPE, and enter HOME DISP, press PUSH, then DIAL to THR/PIT, then press PUSH.

### 2.3.3 End Point of servo travel adjustment (END POINT, also called EPA)

The most flexible version of travel adjustment is available. It independently adjusts each end of each individual servo's travel, rather than one setting for the servo affecting both directions. Again, for CCPM helicopters, be sure to see SWASH AFR prior to adjusting end points.

【END POINT】	
	→ 1: AILE 100/100
CH1: AILE	2: ELEV 100/100
← →	3: THRO 100/100
100% 100%	4: RUDD 100/100
CH9: 75/75	5: GEAR 75/75
CH10: 75/75	6: FLAP 75/75
CH11: 75/75	7: AUX1 75/75
CH12: 75/75	8: AUX2 75/75

Adjustability:

- Can set each direction independently.
- Ranges from 0% (no servo movement at all) to 140%. At a 100% setting, the Throw of the servo is approximately 40° for channels 1-4 and approximately 55° for channels 5-8.
- Reducing the percentage settings reduces the total servo throw in that direction.

Examples:

- Adjust the throttle high end to avoid binding at the carburetor, and low end to allow for proper carburetor closure.
- END POINT may be adjusted to 0 to keep a servo from moving one direction, such as flaps not intended to also operate as spoilers.
- Retract servos are not proportional. Changing END POINT will not adjust the servo.

END POINT adjusts only the individual servo. It will have no effect on any other servo that is operated in

conjunction with this servo via mix or preset programming such as FLAPERON, AILEVATOR, etc. This is so that each individual servo can be carefully fine-tuned to avoid binding and other conflicts. To adjust the total travel of a function such as FLAPERON, make the adjustments in that function's controls. For CCPM helicopters, adjust the total travel of the function, such as collective pitch, in SWASH AFR. Adjust the linkage or the END POINT? It is nearly always best to adjust your linkages to get as close as possible prior to utilizing END POINT. The higher the END POINT setting, the better position accuracy and the more servo power available at nearly any position (except if using digital servos). Higher END POINT values also mean longer travel time to reach the desired position, as you are utilizing more of the servo's total travel. (For example, using 50% END POINT would give you only half the steps of servo travel, meaning every click of trim has twice the effect and the servo gets there in half the time). End point (and moving the linkage) = torque, accuracy, but transit time to get there.

- END POINT (instead of adjusting linkages) = travel time, but torque, accuracy.

Engine idle management: IDLE-DOWN and THR-CUT: functions which work with the digital THROTTLE TRIM to provide a simple, consistent means of engine operation. No more fussing with getting trim in just the right spot for landings or take offs! For additional engine adjustments, see THROTTLE-NEEDLE and THROTTLE DELAY.

Goals	Steps	Inputs
Decrease the flap servo throw in the upward direction to 5% to allow trimming of level flight only and down travel to 85% to prevent binding.	Open END POINT function	for 1s.(If ADVANCE,  again) to END POINT,PUSH
	Choose proper channel and move stick or Knob in direction you want to adjust and set servo throw (Ex: flap up 5%)	to FLAP,PUSH,  to 5%,press
	Close	

### 2.3.4 Trim

TRIM submenu: resets and adjust effectiveness of digital trims.

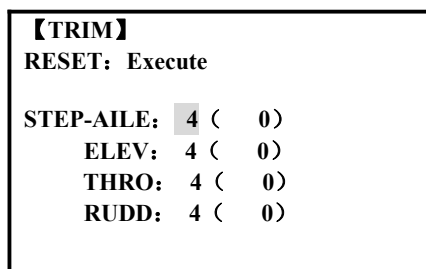

The AT9S has digital trims which are different from conventional mechanical trim sliders. Each TRIM LEVER is actually a two-direction switch. Each time the TRIM LEVER is pressed, the trim is changed a selected amount. When you hold the TRIM LEVER, the trim speed will increase. The current trim position is graphically displayed on the start up screen. The TRIM submenu includes two functions that are used to manage the trim options.

- (1) Trim reset (RESET): Electronically centers the trims to their default values. Note that the SUB-TRIM settings and the trim STEP rate are not reset by this command.
- (2) Trim step (STEP): changes the rate at which the trim moves when the TRIM LEVER is activated. It may be set from 1 to 40 units, depending on the characteristics of the MULTIROTOR. Most ordinary MULTIROTOR do well at about 2 to 10 units. Generally larger trim steps are for models with large control throws or for first flights to ensure sufficient trim to properly correct the model. Smaller trim steps are later used to allow very fine adjustments in flight.

HELI models only: OFFSET is available in the idle ups. If OFFSET is inhibited, adjustment of the TRIM LEVERS will adjust the trims for all flight conditions. If OFFSET is active, then moving the trims within any one condition will affect only that condition.

Goals	Steps	Inputs
Reset trims to neutral after having adjusted all linkage. Note: this is one of the several functions for which the radio requires confirmation to make a change	Open BASIC menu, then open TRIM submenu.	For 1s. (If ADVANCE,  again) TRIM
	Confirm the reset.	to reset,  for 1s. Beep sounds.
Double the sensitivity of the AILERON TRIM LEVERS for a first flight of an aerobatic model to ensure sufficient range to trim the model for level flight.	Adjust the size of the step (Ex: 8)	to AILE, PUSH,  to 8, PUSH
	Repeat for other channel.	to ELEV, PUSH to new setting. Repeat as needed.
	Close	

### 2.3.5 SUB TRIM

SUB-TRIM: makes small changes or corrections to the neutral position of each servo. Range is -120 to +120, with 0 setting, the default, being no SUB-TRIM.

We recommend that you center the digital trims before making SUB-TRIM changes, and that you try to keep all of the SUB-TRIM values as small as possible. Otherwise, when the SUB-TRIM is of large values, the servo's range of travel is restricted on one side.

The recommended procedure is as follows:

- Measure and record the desired surface position;
- Zero out both the trims (TRIM RESET menu) and the SUB-TRIM (this menu);
- Mount servo arms and linkages so that the control surface's neutral is as correct as possible; and
- use a small amount of SUB-TRIM to make fine corrections.

【SUB-TRIM】			
	→	1: AILE	0
CH1:	AILE	2: ELEV	0
	0	3: THRO	0
		4: RUDD	0
CH9:	0	5: GEAR	0
CH10:	0	6: FLAP	0
CH11:	0	7: AUX1	0
CH12:	0	8: AUX2	0

Goals	Steps	Inputs
Adjust the flap servo's SUB TRIM until its center exactly matches the aileron servo's center as they work together as FLAPERON.	Open BASIC menu, then open SUBTRIM	for 1s. (If ADVANCE  again) to SUB-TRIM
	Choose the channel to adjust until surfaces match (Ex: flap)	to FLAP, PUSH,  as needed to each channel.
	Repeat for other channels	as needed.
	Close	

### 2.3.6 Servo Reversing (REVERSE):

Changes the direction an individual servo responds to a CONTROL STICK motion.

☛ Since channel 9 and 10 are switch only, its servo REVERSE is in the AUX-CH control screen with its switch assignment. Be sure to read the section on SWASH AFR before reversing any servos.

Except with CCPM helicopters, always complete your servo reversing prior to any other programming. If you use pre-built ACRO/ GLID functions that control multiple servos, such as FLAPERON or V-TAIL, it may be confusing to tell whether the servo needs to be reversed or a setting in the function needs to be reversed. See the instructions for each specialized function for further details.



【REVERSE】			
		→ 1: AILE	NOR
CH1:	AILE	2: ELEV	NOR
REV	NOR	3: THRO	NOR
		4: RUDD	NOR
CH9:	NOR	5: GEAR	NOR
CH10:	NOR	6: FLAP	NOR
CH11:	NOR	7: AUX1	NOR
CH12:	NOR	8: AUX2	NOR

Always check servo direction prior to every flight as an additional precaution to confirm proper model memory, hook ups, and radio functions.

### Servo reversing

Goals	Steps	Inputs
Reverse the direction of the elevator servo.	Open REVERSE function	(MODE) for 1s .(If ADVANCE (MODE) again) ☺ to REVERSE, PUSH.
	Choose proper channel and set direction(Ex: ELEV REV)]	☺ to ELEV, ☺ to REV, 'Are you sure?' displays ☺ for 1s.
	Close	(END) (END)

### 2.3.7 Dual/triple rates and exponential (D/R, EXP)

Dual/Triple Rates: reduce/increase the servo travel by flipping a switch, or (ACRO GLID) they can be engaged by any stick position. Dual rates affect the control listed, such as aileron, not just a single (ex: channel 1) servo. For example, adjusting aileron dual rate will affect both aileron servos when using FLAPERON or AIL-DIF, and both aileron and elevator servos' travel when using AILEVATOR or ELEVON or a CCPM helicopter.

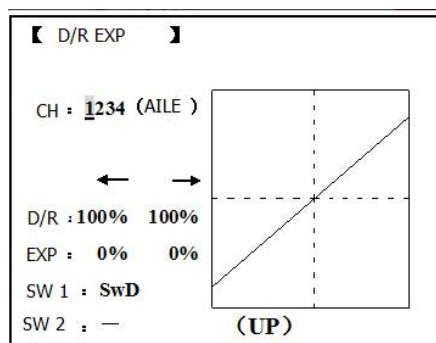

#### Activation:

- Any SWITCH, A-H. If you choose a 3-position switch, then that dual rate instantly becomes a triple rate.
- The glider programming offers you the choice of Condition. This option allows you to have a separate rate for each of condition. (GLID)
- Stick position (ACRO GLID). (Ex: On rudder you normally use only the center 3/4 of the stick movement except for extreme maneuvers such as snaps/spins/stalls. As long as your RUDDER STICK does not exceed 90% (i.e. stall turn), the rudder goes to high rate's 90%, which is a MUCH higher amount of travel than your low rate at 89%)

	Low Rate =50%	High Rate =100%
89%	Low Rate =. 45"	
90%		High Rate =. 9"

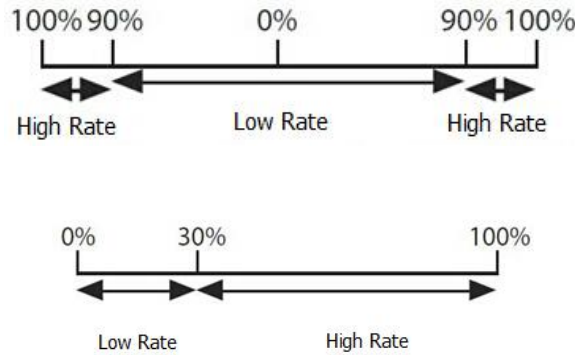

**Adjustability:**

- Range: 0 - 140% (0 setting would deactivate the control completely.) Initial value=100%
- Adjustable for each direction (ACRO/ GLID)  
(i.e. Up/down, left/right) (Ex: Most models fly upright without any elevator trim, but require some down elevator when inverted just to maintain level flight. By increasing the down travel by the amount required to hold the model inverted, the model now has equal travel available from level upright or level inverted.)
- Only if any stick is chosen by the item of "SW1", a switch can also be chosen by the item of "SW2." When operated simultaneously, the switch operation has priority over the stick operation. (ACRO)

**Exponential:**

Change the response curve of the servos relative to the stick position to make fly more pleasant. You can make the servo movement less or more sensitive around neutral for rudder, aileron, elevator, and throttle (except HELI type use THROTTLE CURVE instead). (ACRO type throttle EXP and THROTTLE CURVE can not be activated simultaneously). Many models require a large amount of travel to perform their best tricks.

However, without exponential, they are touchy around neutral, making them unpleasant to fly and making small corrections very difficult. Additionally, by setting different exponentials for each rate, you can make the effectiveness of small corrections similar in each rate, as in our example below:

The best way to understand exponential is to try it:

- Having made no changes yet in the D/R, EXP screen, move SWITCH D to DOWN (toward the AILERON STICK).
- Move SWITCH D up. Hold the AILERON STICK at 1/4 sticks and moves SWITCH D down.
- Notice how much less travel there is.
- Go to 3/4 stick and repeat. Notice how the travel is much closer, if not identical.

Adjustability:

- More sensitive around neutral. (Positive exponential)
- Less sensitive around neutral. (Negative exponential)
- Adjustable for each direction. (ACRO/GLID)

For throttle, exponential is applied at the low end to help nitro and gasoline engines have a linear throttle response, so that each 1/4 stick increases engine RPM 25% of the available range. (In most engines this ranges from 5-60%)

Special note for helicopters: Helicopter model types have just a single rate for each switch position rather than a rate for each side of the servo's travel per switch position. Additionally, setting the D/R, EXP for each switch position requires cursor back to the No. setting and changing the switch position here. Just flipping the switch does not affect the screen setting, allowing dual rates to be assigned with idle-up and other features on certain switches, and does not require putting the model in that condition to make modifications.

Special note for conditions: The helicopter and glider programming offers you the choice of COND. This option allows you to have a separate rate for each of the 3 controls automatically selected when changing conditions, for a total of FIVE rates available. Simply change the switch choice to COND. and then:

(HELI) press the CURSOR LEVER to toggle through the 5 conditions while setting the rates.

(GLID) activate the corresponding condition to edit the rates.

Goals	Steps	Inputs
Set up dual rates and exponential in HELI model.	Open D/R,EXP	for 1s.(If ADVANCE  again) to D/R EXP,PUSH.
	Choose channel	to CH, Push.  to desired channel. PUSH
	Choose first channel position	to NO,PUSH.  to UP,PUSH.
	Set rate and EXP(Ex: High rate=95%,0%exponential)	to Rate, PUSH.  to 95%,confirm 0% EXP.
	Go to 2nd switch position and set rate and exponential.	to NO,PUSH  to DOWN,PUSH.
	Optional: if using a 3 position switch, set 3rd rate.	to NO,PUSH.  to COND repeat above.
	Optional: assign dual rates to have one for each condition.	to SW,PUSH.  to COND. Repeat steps above to adjust for each condition.

Goals	Steps	Inputs
<p>Set up aileron triple rates on SWITCH C with travel settings of 75%(normal) 25%(slow roll)and 140% (extreme aerobatics)and exponential setting of 0%, +15%, and -40% respectively.</p> <p>NOTE: This normal rate has no exponential so it has a Very linear, normal feel. This is slow roll rate has positive exponential (the opposite of what most people normally uses), which makes the servos more responsive around center. This makes the servos feel the same around center in the normal and low rates, but still gives a very slow roll rate at full stick.</p> <p>3D rate (extreme aerobatics) has a very high distance of travel nearly twice that of the normally rate. Therefore, using a very high rate negative exponential setting softens how the servos responses around center stick.</p>	Open D/R,EXP	for 1s to BASIC  to D/R,EXP,PUSH.
	Choose channel to change (Ex:aileron is already selected)	to CH,PUSH,  to AILE,PUSH
	<i>Optional: Change switch position.</i>	to SW,PUSH  to SWC,PUSH
	Confirm switch is in desired position and set rate.(Ex: up=high rate,75%)	to D/R  C to UP position. AILERON STICK  to 75%.PUSH AILERON STICK  to 75%.PUSH
	Move Switch to 2nd rate position and set this particular rate (Ex: center=low rate,25%)	SWC to center position,  to D/R AILERON STICK  to 25%,PUSH AILERON STICK  to 25%,PUSH
	<i>Optional: If using a 3 position SW, move SW to 3rd position and set this rate.(Ex: DOWN=3D rate, 140%)</i>	SWC to DOWN position. AILERON STICK  to 140%,PUSH AILERON STICK  to 140%,PUSH
	<i>Optional: except using a switch, you can set high rates to be triggered when the stick moves past a certain point. To test this, set aileron high rate to 25%.Now set switch assignment to AIL (90%). Move AILERON STICK to the right and notice the huge jump in travel after the stick moves 90% of its distance.</i>	to SWA  to AILE(90%) ,PUSH to D/R AILERON STICK  to 25% AILERON STICK  to 25% AILERON STICK and watch screen graph. See the change? You may also change the trigger point by holding the stick at the desired point then pressing and holding the PUSH.

Set each rate's EXP. (Ex: 0%,+15%,-40%)	to EXP .PUSH C to UP position confirm EXP reads 0. C to DOWN position. AILERON STICK  to+15% .PUSH AILERON STICK  to+15%.PUSH C to center position Repeat to set low rate EXP to -40%.
Repeat above steps for elevator and rudder.	
Close	

### 2.3.8 Throttle Cut

#### AEROBASIC

Throttle cut (THR-CUT) (ACRO0/HELI): provides an easy way to stop the engine by flipping a switch (with THROTTLE STICK at idle). The movement is largest at idle and disappears at high throttle to avoid accidental dead sticks. In HELI, there is an additional setting.

The switch's location and direction must be chosen. It defaults to NULL to avoid accidentally assigning it to a switch, which might result in an unintentional dead stick in flight.

**【THR CUT】**

**MIX: INH**  
**RATE: 0%**  
**THR:5%(100%)**  
**SW: SwH**  
**POST: DOWN**

Goals	Steps	Inputs
Decrease the throttle setting (at idle) to stop the engine with the flip of a switch.(NOTE that you MUST assign a switch. The default is NULL. We recommend SWICH C in the down position, with IDLE-DOWN programmed to SWITCH C in the center and down position.)	Open BASIC menu, then Open THR CUT	for 1s .(If ADVANCE  again) . to THR CUT. PUSH.
	Activate the function .Choose desired switch, and the position which activates the function.	to MIX,PUSH,  to ON,PUSH to SW,PUSH,  SWC,PUSH to POSI,PUSH  to DOWN,PUSH
	With Throttle Stick at idle, adjust the rate.	SWC to DOWN position.
	Until the engine consistently shuts off but throttle linkage is not binding.	Throttle Stick. to Rate.  until shuts off.
	Close	

\*Also LOGIC SW(Lsw1 to 3) may be assigned.

\*\* Normally, a setting of 10-20% is sufficient. Viewing the carburetor barrel until it fully closes is adequate to get an approximate setting; then test with engine running to confirm.

#### GLIDER

Provides an easy way to stop the engine by flipping a switch no matter where the air brake stick is. The movement of servo will be -30%. Now you must select switch position and direction. Factory setting the

position is NULL to avoid an accident setting on a switch to cause glitches during flight.

Adjustability:

- Range: -30% to +30%. Movement of servo is 0%, air brake stick is on its min and -30% on the max.
- SWA-H and logic switch Ls1-3 is selectable
- All position is available for logic switch including NULL (usually MIX OFF), you can set MIX by different position of a switch (UP & CEN, CEN & DN) and also NORM, REV.

Goals	Steps	Inputs
Flip switch to decrease the rate until engine stops. (NOTE: you MUST assign a switch to control which default is NULL)	Open BASIC menu ,then open THR CUT	<b>MODE</b> for 1s .(If ADVANCE <b>MODE</b> again) . ⊖ to THR CUT. PUSH.
	Activate the function Choose desired switch, and the position.	⊖ to MIX,PUSH, ⊖ to ON,PUSH ⊖ to SW,PUSH, ⊖ to desired SW,PUSH ⊖ to POSI,PUSH ⊖ to desired position, PUSH
	Adjust Rate until the engine shuts off.	⊖ to Rate. ⊖ until shuts off.
	Close	<b>END</b> <b>END</b>

## HELICOPTER

This function is used to stop engine after flight is finished. You can set engine powered on/ off, without shifting trim stick to power off and set again every time before flight. Throttle shut for helicopter includes THR ON/ OFF (position above idle down). Before resetting throttle cut, throttle stick must keep below setting point to avoid a sudden speeding up.

☛ Notification: trigger point setting step: under the menu THR CUT, choose THRO by DIAL, and press PUSH and move the throttle stick to trigger point, then press and hold PUSH one second to save. This function only when the throttle stick moves below trigger point.

### 2.3.9 IDLE DOWN (ACRO only)

Lowers the engine idle for: set for sitting on the runway prior to take off, stalls and spins, and landings. The normal idle setting is a little higher for easier starts and safe flights with less risk of dead sticks.

<b>【IDLE DOWN】</b>
<b>MIX: INH</b>
<b>RATE: 0%</b>
<b>SW: SwC</b>
<b>POST: Ct&amp;Dn</b>

Important note: The IDLE-DOWN function is not normally used when starting the engine, and its accidental operation may keep your engine from starting. The AT9S warns that IDLE-DOWN is on when the transmitter is turned on. Be sure to turn off the function, or override the warning by pressing CURSOR lever if you intended the function to be on.

This may be assigned to any switch/position. Some modelers accidentally assign IDLE-DOWN to one side of a switch and THR-CUT to the other. There is no "normal" setting to start the engine. By default IDLE-DOWN is get to SWITCH C center and down. This works well with THR-CUT also on SWITCH C down. The SWITCH C up is normal flight/starting, center for slower maneuvers/landing, and down to cut the engine. If you assign IDLE-DOWN or THR-CUT to the spring-loaded TRAINER SWITCH H or F, then use the trainer function, you may risk loss of throttle control or dead stick for your student.

Goals	Steps	Inputs
Decrease the throttle setting to idle with the flip of a switch for spins and landings.	Open BASIC menu,open IDLE DOWN	for 1s .(If ADVANCE  again) . to IDLE DOWN,PUSH.
	Activate the function	to MIX,PUSH , to OFF
	Adjust the rate until engine idles as desired with Throttle stick.	Throttle Stick down,  to RATE,PUSH, to desired rate, PUSH
	Optional:change switch assignment .	to SW,  to desired position, PUSH.
	Close	

\*Normally a value of 10- 20%. Secure the fuselage, engine running. Set the THROTTLE STICK to idle. Adjust the IDLE-DOWN switch ON and OFF until the desired idle is achieved. Be sure to throttle up periodically to allow the engine to “clean out” and idle reliably.

\*Also LOGIC SW (Lsw1 to 3) may be assigned.

**2.3.10 Fail Safe (F/S)** (loss of clean signal and low receiver battery) submenu (F/S): sets responses in case of loss of signal or low Rx Battery.

【F/S】		
		→ 1: AILE NOR
CH1: AILE		2: ELEV NOR
NOR	<b>F/S</b>	3: THRO 15%
		4: RUDD NOR
CH9: NOR		5: GEAR NOR
CH10: NOR		6: FLAP NOR
CH11: NOR		7: AUX1 NOR
CH12: NOR		8: AUX2 NOR

Adjustability:

- Each channel may be set independently.
- The NOR (normal) setting holds the servo in its last commanded position.
- The F/S (Failsafe) function moves each servo to a predetermined position.
- NOTE: the setting of the throttle's F/S also applies to the Battery F/S.
- The F/S is used in certain competitions to spin the MULTIROTOR to the ground prior to flying away and doing potential damage elsewhere. Conversely, may also be used to go to neutral on all servos, hopefully keeping the plane flying as long as possible.
  - Competition modelers often maintain the NOR function so that brief interference will not affect their model's maneuver.
    - Set the throttle channel so that the engine idles when there is interference (ACRO). This may give enough time to fly away from and recover from the radio interference and minimize damage if crashed.
    - For helicopters, NOR is typically the safest choice.
    - We also recommend setting a gasoline engine's electronic kill switch to the OFF position in the F/S function for safety reasons.

If you specify a F/S setting, the Failsafe data is automatically transmitted once each two minutes. (PCM) When you choose the F/S mode, check that your settings are as desired by turning off the transmitter power switch and verifying that the servos move to the settings that you chose. Be sure to wait at least two minutes after changing the setting and turning on the receiver power before turning off the transmitter to confirm your changes have been transmitted.

Goals	Steps	Inputs
Change the receiver Failsafe command for channel 8(gasoline engine kill switch) to a preset position. NOTE: This is one of several functions for which the radio requires confirmation to make a change.	Open BASIC menu, then Open F/S.	for 1s .(If ADVANCE  again) . to F/S, PUSH
	Choose channel to change(Ex:CH. 8)	to CH8 ,PUSH
	Set and confirm fail safe command.	that controls CH8 to desired OFF position. to adjust ,PUSH
	Repeat as desired	
	Close	

### 2.3.11 Auxiliary Channel Function (including channel 9-12 controls)

(AUX-CH): defines the relationship between the transmitter controls and the receiver output for channels 5-12. Also, the CH9-12 POSI are used to change the CH9-12 servo direction.

Note that the CH9-12 functions are only visible in the AUX-CH screen and modulation mode must be PCM or 2.4G.

Adjustability:

- channels 5-12 may be assigned to any SWITCH (A-H), LOGIC SWITCH (Lsw1-Lsw3), slider [VR(D) and VR(E)], or knob [VR(A-C)] (for example, moving flaps to a switch or slider), but not the primary control sticks (use programmable mixes to do so);
- channel 9-12 may be assigned to any SWITCH (A-H), LOGIC SWITCH (Lsw1-Lsw3) and the servo direction may be changed.
- multiple channels may be assigned to the same switch, slider or knob;
- channels set to "NULL" are only controlled by mixes. (Ex: utilizing 2 channels for 2 rudder servos. See mixes p. 68.)
- If GYRO SENSE, GOVERNOR, and THR-NEEDLE functions are activated, AUX-CH settings of related channels become invalid automatically.

【AUX-CH】	
CH5: SwG	CH1: STK1
CH6: VrA	CH2: STK2
CH7: VrC	CH3: STK3
CH8: VrB	CH4: STK4
CH9: SwB	CH11: SwD
CH10: SwA	CH12: VrE

Related channels:

GYRO SENSE (ACRO): ch. 5, 7, or 8

GYRO SENSE (HELI): ch. 5

GOVERNOR (HELI): ch. 7, or ch. 7 and 8

THR-NEEDLE (ACRO HELI): ch. 8

⚠ Remember that if you assign primary control of a channel to a switch which you later use for other functions (like dual/triple rates or airbrakes), every time you use that other function you will also be moving the auxiliary channel.

Goals	Steps	Inputs
Assign flaps to the right slider[VR(E)] and set channel 7 to NULL in preparation to use it as a smoke system control (the smoke system being activated later by a	Open BASIC menu, then AUX-CH	for 1s .(If ADVANCE  again) . to AUX-CH,PUSH
	Choose channel to change (Ex:CH6)	to CH6,PUSH,  to desired switch, PUSH
	Repeat above steps as desired.	to CH7,PUSH,  to NUL

throttle to CH7 MIX).	(Ex:CH7=NULL)	
	Close	(END) (END)

### 2.3.12 TIMER submenu (stopwatch functions):

Controls three electronic clocks used to keep track of time remaining in a competition time allowed, flying time on a tank of fuel, amount of time on a battery, etc.

【TIMER】			
	<1>OFF	<2>OFF	<3>ON
TIME:	10:00	10:00	---
MODE:	UP	UP	MODEL
ON:	SwA	SwA	---
	NULL	NULL	---
RSET:	SwA	SwA	---
	NULL	NULL	---

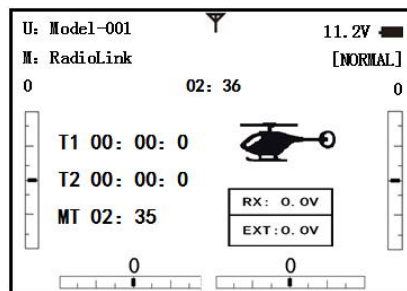







Adjustability:

- Count down timer: starts from the chosen time, displays time remaining. If the time is exceeded, it continues to count below 0.
- Count up timer: starts at 0 and displays the elapsed time up to 99 minutes 59 seconds.
- Count down timer (Stop type): starts from the chosen time, displays time remaining, and stops at 0.
- Model timer: cumulates ON time up to 99 hours 59 minutes each model. Once Model timer function is turned off, the cumulate time will also be reset to "0:00".
- Independent to each model, and automatically updates with model change.
- In either TIMER mode, the timer beeps once each minute. During the last twenty seconds, there's a beep each two seconds. During the last ten seconds, there's a beep each second. A long tone is emitted when the time selected is reached. (UP/DOWN TIMER)
- To Reset, choose the desired timer with the CURSOR lever (while at the startup screen), then press and hold DIAL for 1 second.
- Activation by either direction of SWITCH A-H, by THROTTLE STICK (STK-THR) (Using the THROTTLE STICK is convenient if you are keeping track of fuel remaining, or for an electric, how much battery is left), by LOGIC SWITCH Lsw1-Lsw3 or by the power SWITCH (PWR SW).
- Also the reset switch can be assigned (SWITCH A-H or LOGIC SWITCH Lsw1-Lsw3)

Goals	Steps	Inputs
Set timer 2 to count down 4 1/2 minutes, being controlled by Throttle Stick position. This utilized to keep track of actual Throttle on time to better cooperate with fuel/battery usage.	Open BASIC menu, then to TIMER	(MODE) for 1s .(If ADVANCE (MODE) again) . (DIAL) to TIMER ,PUSH
	Go to TIMER <2>	(DIAL) to TIMER <2> ,PUSH
	Adjust time to 4min.30sec., count down	(DIAL) to 4,PUSH. (DIAL) to 00 TIMER<2>,PUSH (DIAL) to 30,PUSH



	Assign switch at ST-THK and set trigger point.	 to SWA TIMER<2>,  to ST-THK, PUSH  Throttle Stick down to 50%, PUSH for 1s to NULL.  Throttle Stick down to desired position(Ex:1/4 stick) PUSH button for 1s to set.
	Close	 

### 2.3.13 TRAINER:

For training novice pilots with optional trainer cord connecting 2 transmitters. The instructor has several levels of controllability.

<b>【TRAINER】</b>	
→	1: AILE FUNC
	2: ELEV FUNC
<b>INH</b>	3: THRO FUNC
CH1: AILE	4: RUDD FUNC
FUNC	5: GEAR FUNC
	6: FLAP FUNC
	7: AUX1 FUNC
	8: AUX2 FUNC

Adjustability:

- NORM: When the TRAINER SWITCH is ON, the channel set to this mode can be controlled by the student. The set channel is controlled according to any programming set at the student's transmitter.
- FUNC: When the TRAINER SWITCH is ON, the channel set to this mode can be controlled by the student, controlled according to any mixing set at the instructor's transmitter.
- MIX: When the TRAINER SWITCH is ON, the channel set to this mode can be controlled by both the student and the instructor, controlled according to any mixing set at the instructor's transmitter. And the student's mixing rate is adjustable. (Default 30%)

[Note] However, it becomes invalid even if it sets up the channel which is not in a student's transmitter. The channel serves as operation by the instructor's transmitter automatically.

- OFF: The channel set to this mode cannot be controlled by the student even when the TRAINER SWITCH is ON. The set channel is controlled by the instructor only, even when the TRAINER SWITCH is ON.

- SWITCH: controlled by spring-loaded SWITCH H only. Not assignable.
- Compatibility: The AT9S may be master or student with any Radiolink transmitter compatible with the cord. Simply plug the optional trainer cord (For AT9S series, sold separately) into the trainer connection on each transmitter, and follow the guidelines below.

EXAMPLES:

- When throttle/collective is set to FUNC, 5-channel helicopter practice is possible with a 4-channel transmitter.
- Set up the model in a second transmitter, use NORM mode to quickly and safely check proper operation of all functions, and then allow the student radio to fully fly the model.
- Using NORM mode, set lower throws, different exponentials, even different auxiliary channel settings on the student radio (if it has these features).
- To ease the learning curve, elevator and aileron may be set to the NORM or FUNC mode, with the other channels set to OFF and controlled by the instructor.

☛ NOTE:

- NEVER turn on the student transmitter power.
- ALWAYS set the student transmitter modulation mode to PPM.
- BE SURE that the student and instructor transmitters have identical trim settings and control motions. Verify by switching back and forth while moving the control sticks.
- FULLY extend the instructor's antenna. Collapse the student's antenna. (Except 2.4GHz)

- When the TRAINER function is active, the snap roll function is deactivated. Other functions, such as IDLE-DOWN and THR-CUT, which have been assigned to the same switch, are not deactivated. Always double check your function assignments prior to utilizing the TRAINER function.
- When you select a different model, the TRAINER function is deactivated in the current model for safety reasons.

Goals	Steps	Inputs
Turn on the TAINER system and set up so student has :fully functional control of aileron and elevator to support FLAPERON &AILERON; normally control of rudder to allow lowered travel; and no throttle channel control(with the instructor for safety)	Open BASIC menu, then Open TRAINER	(MODE) for 1s .(If ADVANCE (MODE) again) . to TRAINER ,PUSH
	Activate TRAINER	PUSH, to PUSH
	Choose desired channels and proper training types	past AIL and ELE(default FUN) to THR,PUSH, to OFF, PUSH to RUD, PUSH, to NORM,PUSH
	Close	(END) (END)
	Test student radio function prior to attempting to fly!	

### 2.3.14 Logic Switch Selection (LOGIC SW):

The various functions in the AT9S can be selected by switch..

The Logic switch can be assigned to the functions as following: THR-CUT, IDLE DOWN, AUX-CH, TIMER, PROG. MIX, AIRBRAKE, ELEV-FLAP, and AILE-FLAP. The logic switch can activate functions by two switches combination. The 2 types of logic, either AND or OR, can be selected.

SW		OUT	
SW (1)	SW (2)	AND	OR
OFF	ON	OFF	OFF
OFF	ON	OFF	ON
ON	OFF	OFF	ON
ON	ON	ON	ON

LSW	1(OFF)	2(OFF)	3(OFF)
SW	SwA	SwA	SwA
POST	NULL	NULL	NULL
MODE	x/and	x/and	x/and
SW	SwA	SwA	SwA

Adjustability:

- Three logic switches can be used. (LSW1, LSW2, and LSW3 )
- SW (1): Any SWICH A-H or THRSTKS, SW (2): Any SWICH A-H
- Switch position (POST)
- Logic mode: AND or OR (MODE)

### 2.3.15 SERVO display and cycle submenu:

Displays radio's output to channels 1-12.

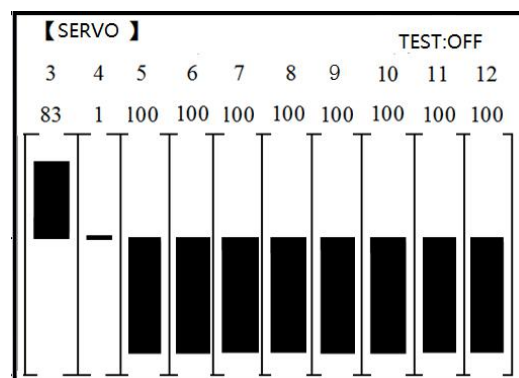
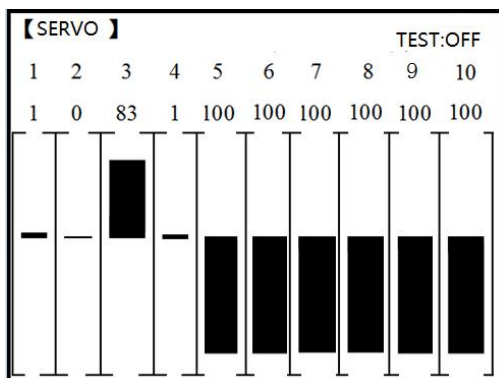

The servo submenu includes two features:

- Real-time bar-graph display to demonstrate exactly what commands the transmitter is sending to the servos. (This can be particularly handy in setting up models with complicated mixing functions, because the results of each stick, lever, knob, switch input and delay circuit may be immediately seen.)
- Servo cycle function to help locate servo problems prior to in-flight failures. (Channels 1-12)

Goals	Steps	Inputs
View the result of reassigning channel 6 from VR(A) knob to three-position SWITCH C Cycle the channel 6 servo.	Complete desired programming function.(Ex: in AUX-CH,move ch.6 to	See AUX-CH for details.
	Open SERVO function	<b>MODE</b> for 1s.(If ADVANCE <b>MODE</b> again) . to SERVO ,PUSH
	Move each control to see the operation.(Ex: SWITCH C in all positions)	C to center position. Note change in position of ch.6 servo.
	Prepare all servos to be cycled and cycle	Plug in servos. Power on.
	Close	<b>END</b> <b>END</b>

### 2.3.16 TELEMETARY

Signal strength and receiver voltage integrated into the radio transmitter. It is displayed as the following configure, also it is in the sub menu RECEIVE.

Receiver voltage is shown as RX,  
External voltage is shown as EXTY.

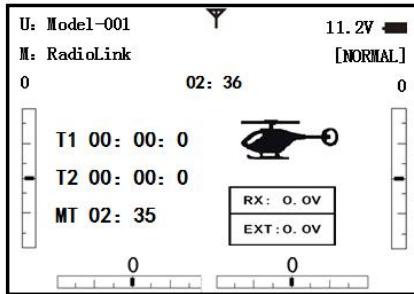

Find telemetry information: under BASIC MENU, select RECEIVE, presses PUSH to enter, you can find the telemetry info, shown as below. RX is receiver voltage, EXT is external voltage. Also temperature and engine speed (EXT, TEMPERATURE, RPM, and GPS all need telemetry sensor).

RSSI is signal strength, NULL is for no signal, and 0 is for max.

Connection of telemetry sensor: sensor of EXT, TEMPERATURE, RPM, GPS can connect one by one with the receiver port DATA.

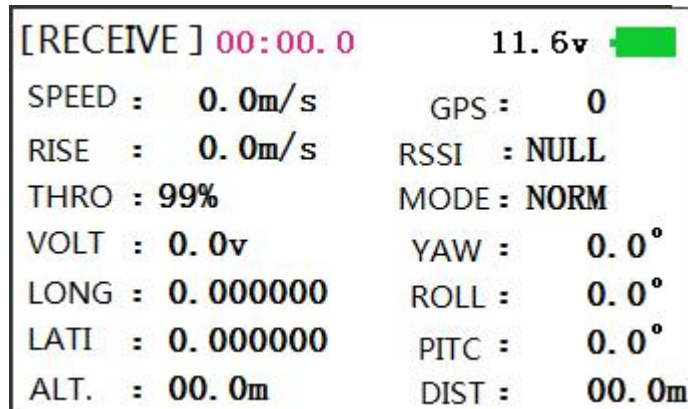

Linkage as below:

Connect to telemetry module PRM-01

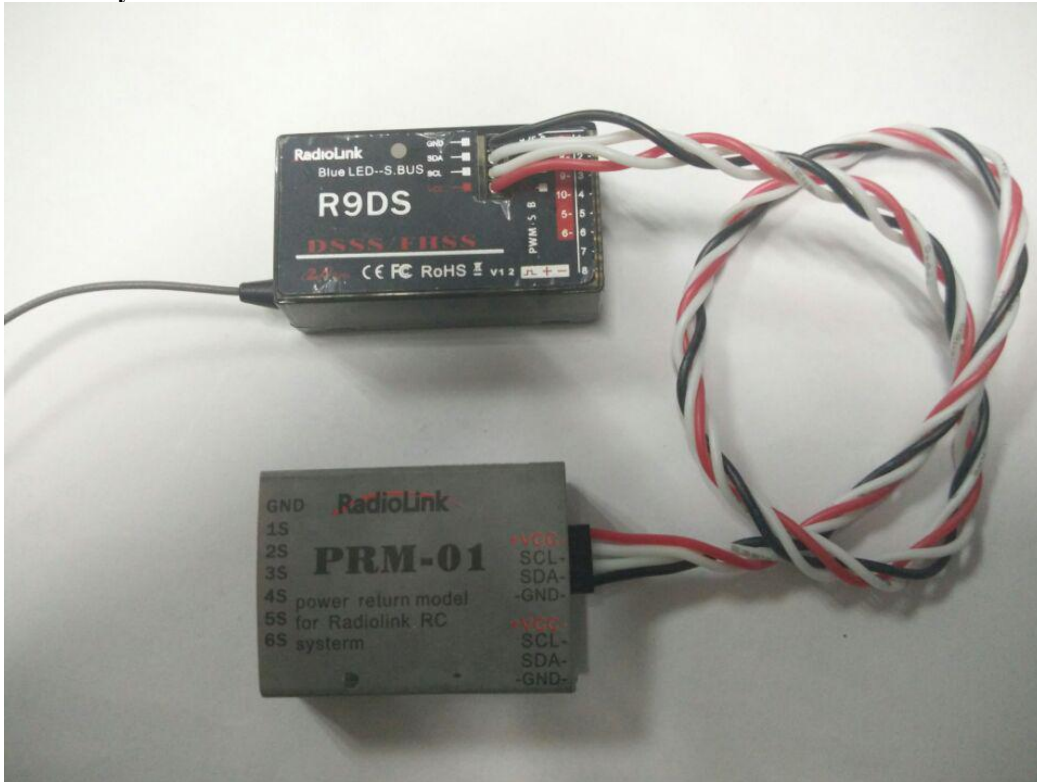

Connect to telemetry module PRM-02

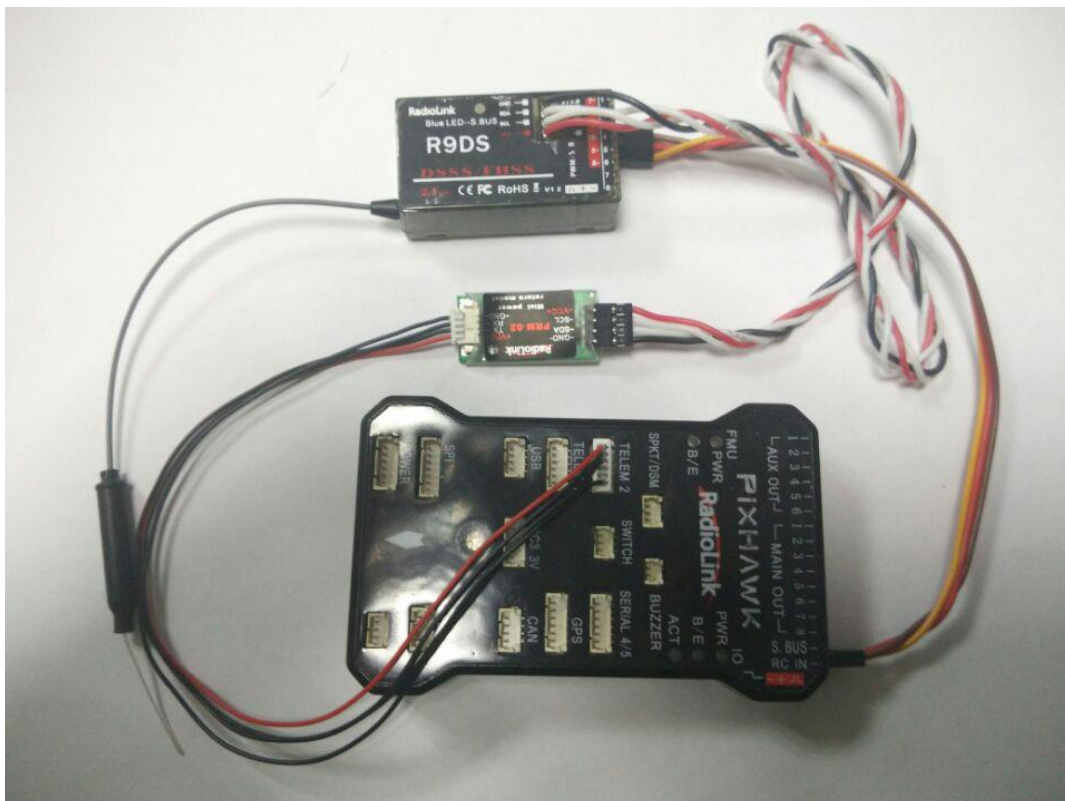

## Part 3. ACRO ADVANCE MENU FUNCTIONS

### 3.1 AIRPLANE WING TYPES (ACRO/GLID):

There are 3 basic wing types in MULTIROTOR models:

- Simple. Model uses one aileron servo (or multiple servos on a Y-harness into a single receiver channel) and has a tail. This is the default setup and requires no specialized wing programming.
- Twin Aileron Servos. Model uses 2 aileron servos and has a tail. See TWIN AILERON SERVOS.
- Tail-less models (flying wing). Model uses 2 wing servos working together to create both roll and pitch control. See ELEVON.

Twin Aileron Servos (with a tail) (ACRO/GLID): Many current generation models use two aileron servos, plugged into two aileron servos, plugged into two separate receiver channels. (If your model is a flying wing without separate elevators, see ELEVON)

ADVANTAGE:

- Ability to adjust each servo's center and end points for perfectly matched travel.
- Redundancy, for example in case of a servo failure or mid-air collision.
- Ease of assembly and more torque per surface by not requiring torque rods for a single servo to drive 2 surfaces.
- Ease of assembly and more torque per surface by not requiring torque rods for a single servo to drive 2 surfaces.
- Having more up aileron travel than down travel for straighter rolls, aileron differential. (See glossary for definition.)
- Set a negative percentage to reverse the operation of one of the servos.

Options:



- 5-channel receiver. Set up AILE-2 prior to continuing with FLAPERON or AIL-DIFF.
- FLAPERON:
  - Uses CH6 for the second servo
  - Allows flap action as well as aileron action from the ailerons.
  - Provides FLAP-TRIM function to adjust the neutral point of the FLAPERON for level flight.
  - Also allows aileron differential in its own programming (instead of activating AIL-DIFF).
  - Uses CH7 for the 2nd servo (see AIL-2 use CH5)
  - Leaves CH5 & CH6 free for flap operation, such as FLAPERON and flap action together, in AIRBRAKE.
  - Allows for more up aileron travel than down for straighter rolls. You will need to choose which of FLAPERON or AIL-DIFF is better for your model's setup. If you need the ailerons to also operate as flaps, you most likely want to use FLAPERON. If your model has 2 aileron servos and flaps, then AIL-DIFF is probably the easiest choice.





NOTE: Only one of the three wing-type functions (FLAPERON, AIL-DIFF, and ELEVON) can be used at a time. All three functions cannot be activated simultaneously. To activate a different wing type, the first must be deactivated.

### 3.2 TWIN AILERON SERVOS (5-channel receiver, AILE-2 , ACRO/GLID)

AILE-2 allows FLAPERON and AIL-DIFF with a 5-channel receiver. AILE-2 only tells the radio that you are using CH5 and CH6 (FLAPERON), or CH5 and CH7 (AILDIFF), not CH6 or CH7, as the second servo in FLAPERON or AILE-DIFF. You still must activate and set up the FLAPERON/AILE-DIFF function.

☛ Note that selecting CH6&5 or CH7&5 does NOT free up CH6 or CH7 to be used for other functions when using a receiver with more than 5 channels. Both 5 and 6 (FLAPERON/AILE-DIFF) are dedicated to the FLAPERON or AILE-DIFF programming. [This is beneficial with four aileron servos that need to have their end points or sub-trims set separately. CH1, CH5 and CH6 are already fully set up to operate as ailerons. Mix the CH7 or CH8 (the second aileron servo on the other side) into ailerons to function properly.

Goals	Steps	Inputs
Adjust the 2 <sup>nd</sup> aileron servo output from CH6or7 to	Open PARAMETER submenu.	 For 1s. (If ADVANCE  again) .  to PARAMETER ,PUSH

channel CH6&5 Allow twin aileron servos operating with a 5-channel receiver.	Select AILE-2 and change to CH6&5.	 To AILE-2.  to CH6&5
	Close	 

There are 4 basic tail types in MULTIROTOR models:

- Simple. Model uses one elevator servo and one rudder servo (or multiple servos on a Y-harness). This is the default.
- Dual Elevator servos. Model uses 2 elevator servos.
- Tail-less models. Model uses 2 wing servos together to create roll and pitch control. See ELEVON (ACRO/GLID 1A+1F).
- V-TAIL. Model uses 2 surfaces, at an angle, together to create yaw and pitch control. see V-TAIL (ACRO/GLID).

⚠ Note: Only one of the three tail-type functions (AILEVATOR, V-TAIL, and ELEVON) can be used at a time. The radio provides a warning and will not allow the activation of another tail type until the first is deactivated. An error message of OTHER WING MIXING IS ON will display.

Using ELEVON (ACRO/GLID 1A+1F): it is used with delta wings, flying wings, and other tailless MULTIROTOR that combine aileron and elevator functions, using two servos, each one on the ELEVON. The aileron/elevator responses of each servo can be adjusted independently. This is also popular for ground model use, such as tanks, which drive two motors together for forward, and one motor forward/ one backward for turning.

### 3.3 ACRO ADVANCE FUNCTION MENU

Mixes are special programs within the radio that command one or more channels to act together with input from only one source, such as a stick, slider or knob.

There are a variety of types of mixes:

TYPE:

- Linear: Most mixes are linear. A 100% linear mix tells the slave servo to do exactly what the master servo is doing, using 100% of the slave channel's range to do so. An example is FLAPERON, when aileron stick is moved, the flap servo is told to move exactly the same amount. A 50% linear mix would tell the slave servo, for example, to move to 50% of its range when the master's control is moved 100%.
- Offset: An OFFSET mix is a special type of linear mix. When the mix is turned on (usually a flip of a switch), the slave servo is moved a set percent of its range. An example of this is AIRBRAKE, moving flaps, FLAPERON, and elevator all to a set position at the flip of a switch.
- Curve: Curve mixes are mostly used in helicopters, but may also be used in airplanes and gliders. An example is THROTTLE-NEEDLE mixing, where the in-flight needle's servo is moved, changing the mixture, as the throttle servo is moved.
- Delay: Delay mixes are part of a few very special functions that make the servo move to its desired range more slowly.

THROTTLE DELAY (simulates turbine engines) and the elevator delays in AIRBRAKE are two examples of this. DELAY in HELI is another example that slows the servo movement to the trim settings for the other conditions.

Essentially every feature in the radio's programming is really a mix, with all assignments/programming set up and ready to use. Additionally, the AT9S ACRO and GLID programs both provide 4 linear and 4 curve fully-programmable mixes ( HELI provides 4 linear and 2 curve) that allow you to set up special mixes to resolve flight difficulties, activate additional functions, etc.

Let's look quickly at a few examples that are features we've already covered. This may help to clarify the mix types and the importance of mixes:

Additional example:

- Exponential is a preprogrammed curve mix that makes the servos' response more (+) or less (-) sensitive around center stick (works in conjunction with dual rate, a linear mix that adjusts the total range). see D/R,EXP,
- IDLE-DOWN and THR-CUT are two OFFSET pre-programmed mixes. These tell the throttle servo, when below a certain point, to move toward idle an additional set percentage to help close the carburetor.
- ELEV-TO-FLAP mixing is a pre-programmed linear mix to move the flaps proportionally to elevator control, helping the model loop even tighter than it can on elevator alone.

- THROTTLE-NEEDLE mixing is a curve mix (like PROG.MIX 5 to 8) for proper in-flight needle setup.
- THROTTLE DELAY mixing is a pre-programmed delay mix that slows down the response of the CH3 servo.

Next, we'll get an in-depth look at some pre-programmed mixes (mixes whose channels are predefined for simplicity) we've not covered yet, and last, look at the fully-programmable mix types.

### 3.3.1 Program MIX

[PROG MIX]		[PROG.MIX1]	
-normal-	-curve-	RATE ← : 0%	MIX:INH
1:INH	5:INH	→ : 0%	
2:INH	6:INH	OFFSET: 0%	TRIM:OFF
3:INH	7:INH	(- 0%)	LINK: OFF
4:INH	8:INH	MASTER:CH1	SW:SwB
		SLAVE:CH4	POST:NULL

AT9S contains four separate linear programmable mixes. (Note that mixer #5-8's mixing RATE are set with a 5-point curve. HELI has mixer #5-6's mixing. See CURVE MIXES

There are a variety of reasons you might want to use these mixes. A few are listed here. All of the adjustable parameters are listed below, but don't let them scare you. For your first few times experimenting with mixes, just turn on the default mixes, adjust them how you think they need to be, then use the servo screen to check and see if you were correct. As with all functions, a sample setup follows, step by step, to assist you.

Sample reasons to use linear programmable mixes:

- To correct bad tendencies of the MULTIROTOR (such as rolling in response to rudder input).
- To operate 2 or more servos for a single axis (such as two rudder servos).
- To automatically correct for a particular action (such as lowering elevator when flaps are lowered).
- To operate a second channel in response to movement in a first channel (such as increasing the amount of smoke oil in response to more throttle application, but only when the smoke switch is active).
- To turn off response of a primary control in certain circumstances (such as simulating one engine flaming out on a twin, or throttle-assisted rudder turns, also with a twin).

Adjustability:

- Defaults: The 4 programmable mixes default to the most frequently used mixes for simplicity. If you want to use one of these mixes, simply select that mix number so that the master and slave servos are already selected for you.
- PROG.MIX1 aileron-to-rudder for coordinated turns
- PROG.MIX2 elevator-to-flap for tighter loops (HELI mixes default to ELEV-to-pitch.)
- PROG.MIX3 flap-to-elevator to compensate pitching with flaps (HELI mixes default to pitch-to-ELEV)
- PROG.MIX4 throttle-to-rudder ground handling compensation
- Channels available to mix: All four mixes may use any combination of CH1-8. (CH9-10 is not proportional and cannot be mixed.) Offset and dials may also be set to the master channels.
- Master: the controlling channel, the channel whose movement is followed by the slave channel.
- Another channel: Most mixes follow a control channel. (Ex: rudder-to-ailerons, 25%, no switch, corrects roll coupling.)

MASTER	SLAVE	LINK	TRIM	SWITCH	POSITION	RATE	OFFSET
RUDD	AILE	ON	OFF	ANY	NULL	25%	0

- Offset as master: To create an OFFSET mix, set the master as OFST. (Ex: Move FLAPERON as flaps 20% of their total throw when SWITCH C is in down position.)

MASTER	SLAVE	LINK	TRIM	SWITCH	POSITION	RATE	OFFSET
OFST	FLAP	ON	N/A	C	DOWN	20%	0

- Dial as master: To directly effect one servo's position by moving a dial, set the master as the desired dial.

(Ex: create a second throttle trim on left slider.)

MASTER	SLAVE	LINK	TRIM	SWITCH	POSITION	RATE	OFFSET
VR(D)	THRO	OFF	N/A	ANY	NULL	5%	0

•Slave: the controlled channel. The channel is moved automatically in response to the movement of the master channel. The second channel is in a mix's name (i.e. aileron-to-rudder).

•Link: Link this programmable mix with other mixes.

Ex: PMIX FLAP-ELEVATOR mixing to correct for ballooning when flaps are lowered, but model has a V-tail. Without LINK, this mix only moves CH2 elevator when flap is commanded, resulting in a dangerous combination of yaw and roll. With LINK ON, mixing is applied to both CH2 and CH4.

MASTER	SLAVE	LINK	TRIM	SWITCH	POSITION	RATE	OFFSET
FLAP	ELEV	ON	OFF	ANY	NULL	5	0

•Trim: Master's trim affects slave. Not displayed if master is not CH 1-4, because 5-9 have no trim. Ex: two rudder servos. With TRIM OFF, rudder trim would bind the two servos. TRIM ON resolves this.

• On/off choices:

• SWITCH: Any of the positions of any of the 8 switches may be used to activate a mix. Up&Cntr, Cntr&Dn options allow the mix to be ON in 2 of the 3 positions of a 3-position SWITCH.

• NULL: No SWITCH can turn this mix OFF. This mix is active at all times.

• LOGIC SW (Lsw1 to 3) may be assigned.

• STK-THR: Turn on/off by THROTTLE STICK movement. Trigger point/direction are selectable. Ex: OFST-to-(gear doors) mix to open gear doors at idle, which is only active if throttle is below half.

MASTER	SLAVE	LINK	TRIM	SWITCH	POSITION	RATE	OFFSET
OFST	AUX2	OFF	ON	STK-THR	Stick at 1/2.for 1 sec.	100%	0

• Rate: the percentage of the slave's range it will move upon maximum input from the master channel. Ex: RUDDERAILERON mix, 50%. Ail range=1". When rudder is moved full right, ailerons move 1/2".

MASTER	SLAVE	LINK	TRIM	SWITCH	POSITION	RATE	OFFSET
RUDD	AILE	OFF	OFF	ANY	NULL	50%	0

• Offset: Offsets the slave's center is relative to the master. Ex: Smoke valve opens wider per throttle servo position when smoke SWITCH is ON. Smoke servo's neutral is moved down from THROTTLE STICK center to the bottom.

MASTER	SLAVE	LINK	TRIM	SWITCH	POSITION	RATE	OFFSET
THRO	AUX2	OFF	OFF	E	DOWN	100%	100

Goals	Steps	Inputs
Set up a FLAP-ELEV mix: ON when SWITCH C is in the down position. No elevator movement when flaps move	Open an unused programmable mix.(Ex: use PROG.MIX3 since it is already set up for FLAP-ELEVATOR)	to BASIC menu,  again to ADVANCE to PROG.MIX PUSH
	Activate the function	to MIX,PUSH,  to ON, PUSH



	Choose master and slave channels.	Already CH6 .Already CH2
	Optional: set Master as OFST or VR(A-E)	⊗ to Master,PUSH, ⊗ to desired choice
	Set LINK and TRIM as needed.	⊗ to LINK,PUSH, ⊗ to DWON
	Assign SWITCH and position. (Ex: change from E to C,Down)	⊗ to SW,PUSH, ⊗ to SwC ⊗ to POSI,PUSH ⊗ to DOWN
	Optional: set switch to STK-THR to activate mix with THROTTLE STICK.	⊗ to SW ,PUSH ⊗ to STK-THR ⊗ to POSI, ⊗ Throttle Stick to desired point . ⊗ Push 1sec.to set.
	Optional: set switch position to NULL. Make mix active at all time. Not complete with STK-THR.	⊗ to POSI, PUSH, ⊗ to NULL
	Set rate. (Ex: Lo=0%,Hi=5%)	⊗ to RATE ,PUSH ⊗ VR(A), ⊗ leave at 0%, ⊗ VR(A)past center . ⊗ to 5%
	Set OFF SET, if needed. (Ex: 0)	⊗ to OFST ⊗ to 0%
	Close	END END

Other samples:

- RUD-ELEV (ACRO GLID) mix: Compensate for pitching up or down when rudder is applied.
- AIL-RUD mix (ACRO): Coordinate turns by applying rudder automatically with aileron input. All model types.
- ELEV-PIT (HELI) mix: Compensate for the loss of lift of tilting the model

### 3.3.2 Curve Programmable Mixes (PROG.MIX5-8)(HELI: PROG.MIX5-6):

AT9S's ACRO/GLID programs contain four separate curve programmable mixes. HELI contains two. There are a variety of reasons you might want curve mixes. Usually a linear mix doesn't fit your needs along the whole range. One pre-programmed curve mix is the THROTTLE-NEEDLE function. This curve is adjustable at 5 points, allowing you to adjust the motor's tuning at 5 points along its RPM range.

One programmable curve mix defaults to RUDDER-AILERON. A linear mix that keeps the model from rolling in knife-edge is probably too much aileron when rudder is applied in level flight. Create a curve mix and set all 5 points to match the linear mix. Inhibit the linear mix, and then adjust the curve to get the right response all along the rudder channel's travel.

[PROG MIX]	
-normal-	-curve-
1:INH	5:INH
2:INH	6:INH
3:INH	7:INH
4:INH	8:INH

[P.MIX5 CURVE]	
MIX:INH	POINT-5> 0%
	4> 0%
	3 0%
	2> 0%
	1> 0%
	MAS:CH1
	SLV:CH2
	SW:SwF
	POST:NULL

#### ADJUSTABILITY:

- ACRO/GLID Defaults: The 4 programmable curves mixes default to the most frequent choices, but can be set to any channel.
- PROG.MIX5 rudder-to-aileron for roll coupling compensation (GLID mixes default to aileron-to-ELEV.)
- PROG.MIX6 rudder-to-aileron for roll coupling compensation (GLID mixes default to aileron-to-ELEV.)
- PROG.MIX7 rudder-to-elevator for pitch coupling compensation (GLID mixes default to elevator-to-airbrake.)
- PROG.MIX8 rudder-to-elevator for pitch coupling compensation (GLID mixes default to elevator-to-airbrake.)
- HELI Defaults:
- PROG.MIX5 aileron-to-elevator for coordinated turns
- PROG.MIX6 aileron-to-elevator for coordinated turns
- Master: The controlling channel can only be a channel. Cannot OFFSET or dial.
- Trim: not available in curve mixes.
- Offset: not available in curve mixes.

Goals	Steps	Inputs
Set up a RUDD-ELEV curve mix on a model that pitches down severely at full rudder and not at all with minimal rudder input, and pitches worse on right rudder than left:  Point 1: 25% Point 2: 8% Point 3: 0% Point 4: 10% Point 5: 28%  ON when <b>SWITCHC</b> is down. LINK should be ON if model has twin elevator servos. Otherwise, LINK remains OFF. (Note that point 3 is 0%. Otherwise, the elevator would be retrimmed when the mix is active and no rudder input is given.)	Open an unused programmable mix. (Ex: use PROG.MIX7 since it is already set up for FLAP-ELEVATOR)	(MODE) to BASIC menu, (MODE) again to ADVANCE (R) to PROG.MIX PUSH (R) 7,PUSH
	Activate the function	(R) to MIX,PUSH, (R) to ON, PUSH (R)
	Choose master and slave	Already RUDD. Already ELEV
	Set LINK as needed( Ex: off)	
	Assign SWITCH and position. (Ex: change from F to C,Down)	(R) to SW.PUSH. (R) to C,PUSH (R) to POSI, PUSH. (R) to DOWN
	Optional: set switch to STK-THR to activate mix with THROTTLE STICK.	(R) to POSI, (R) Throttle Stick to desired point . (R) Push 1sec. to set.
	Optional: set switch position to NULL. Make mix active at all time. Not complete with STK-THR.	(R) to POSI, PUSH, (R) to NULL
	Set desired percent at five stick points.	(R) to POINT -1 (R) to 25% , (R) Repeat for points 2-5.
Close	(END) (END)	

### 3.3.3 FLAPERON (ACRO/GLID 1A+1F ):

<b>【FLAPERON】</b> <b>MIX: INH</b>  (L) (R) <b>RATE-AIL1: +100% +100%</b> <b>AIL2: +100% +100%</b> <b>FLP2: +100%</b> <b>FLP1: +100%</b>	<b>【FLPERON】</b> <b>MIX: INH</b> <b>NORMA ←</b> (L) (R) <b>START</b> <b>RATE-AIL1: +100% +100%</b> <b>SPEED</b> <b>AIL2: +100% +100%</b> <b>DISTA</b> <b>FLP2: +100%</b> <b>LANDI</b> <b>FLP1: -100%</b> <b>B.FLY-ADJ: 25%</b>
ACRO	GLID

The FLAPERON mixing function uses one servo on each of the two ailerons, and uses them for both aileron and flap function. For flap effect, the ailerons raise/lower simultaneously. Of course, aileron function (moving in opposite directions) is also performed.

• Note: When changing the polarity of a rate, "change rate dir?" is displayed for a check. Please set up after pressing DIAL for 1 second and canceling an alarm display. (GLID only)

Once FLAPERON is activated, any time you program CH6 or "flap" (i.e. ELEVATOR mixing), the radio commands both servos to operate as flaps. The amount of travel available as flaps is independently adjustable in FLAPERON. A trimming feature is also available (see FLAP-TRIM) to adjust both neutral positions together for straight-and-level flight or slight increases/decreases of the flap angle. END POINT and SUB-TRIM both still adjust each servo individually.

Adjustability:

- Each aileron servo up travel can be set separate from its down travel, creating aileron differential. (See example).
- Each aileron servo's travel when actuated as a flap is separately adjustable.
- AILE-2 can be utilized to use a 5-channel receiver and still have FLAPERON. NOTE: The AILE-2 function only commands the channel 5 servo to operate with the aileron servo as ailerons, and to obey the primary flap control (travel adjusted in FLAP-TRIM.) It does not provide full flap mix capability as when using a 6+ channel receiver and channel 6.
- The separate FLAPERON settings for each condition can be set. (GLID)

• Note: Activating FLAPERON only makes the ailerons work as ailerons and tells the radio how far you want them to move as flaps. If you then activate other programming that moves them as flaps.

FLAP-TRIM is the flap-trimming feature that allows the flaps to move in reaction to the channel 6 control. It is meant only for trimming the flaps' center but can also be used as full flap control.

ELEVATOR-FLAP would add elevator mixing into the flap movement from the flap dial after FLAP-TRIM is activated.

Goals	Steps	Inputs
Activate twin aileron servos, FLAPERON. Input 10% less down travel than up travel (aileron differential) within the FLAPERON programming. (Decrease right aileron down travel to 90%, decrease left aileron down travel to 90%) Adjust total flap travel available to 50% of aileron travel available.	Open the FLAPERON.	<input type="button" value="MODE"/> to BASIC menu, <input type="button" value="MODE"/> again to ADVANCE <input type="button" value="FLAPERON"/> to FLAPERON .PUSH.
	Activate the function.	<input type="button" value="MIX"/> to MIX. PUSH. <input type="button" value="ACT"/> to ACT
	Optional: adjust the up/down travel for 2 servos. (Ex: 90% down)	<input type="button" value="AILE1"/> to AILE1 <input type="button" value="AILERON STICK"/> AILERON STICK. <input type="button" value="90%"/> to 90% <input type="button" value="AILE2"/> to AILE2, <input type="button" value="AILERON STICK"/> AILERON STICK, <input type="button" value="90%"/> to 90%
	Optional: Use as total flap control. Resign CH6 is primary control in AUX-CH to desired flap control. (Ex: right slider)	<input type="button" value="FLAP2"/> to FLAP2 PUSH, <input type="button" value="+50%"/> to +50% <input type="button" value="FLAP1"/> to FLAP1. PUSH <input type="button" value="-50%"/> to -50%
	Close	<input type="button" value="END"/> <input type="button" value="END"/>

\* If you receive an error message that OTHER WING MIXING IS ON, you must deactivate AIL-DIFF or ELEVON.

### 3.3.4 FLAP-TRIM

Using FLAP-TRIM to adjust FLAPERON (ACRO/GLID)

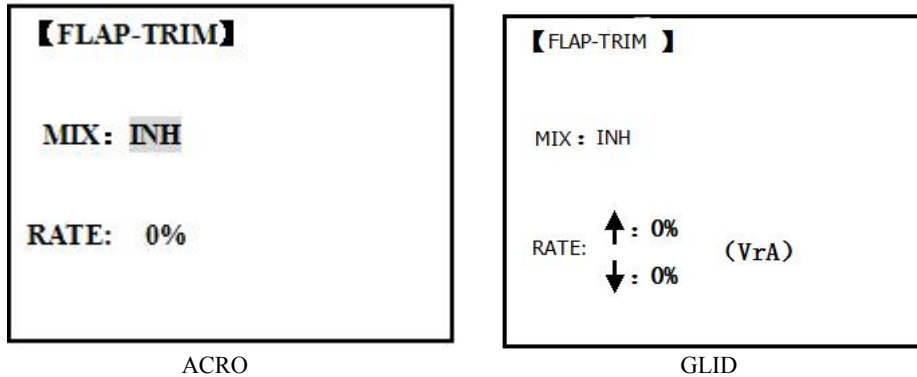

FLAP-TRIM assigns the primary FLAPERON control [defaults to VR(A)] to allow trimming in flight of the flap action of FLAPERON.

☛ Note: Even if FLAP-TRIM is made active with AIL-DIFF, it will not have any effect. The ONLY function that allows control of the ailerons as flaps in the AIL-DIFF configuration is AIRBRAKE. Most modelers use AIRBRAKE, or programmable mixes, to move the flaps to a specified position via movement of a switch.

FLAP-TRIM may also be used as the primary flap control in flight. By doing so, you can assign CH6 to a 3-position switch, with a "SPOILERON", neutral, and "FLAPERON" position, and even adjust the percentage traveled as FLAPERON/SPOILERON by changing the Flap Trim travel.

Goals	Steps	Inputs
Add FLAP-TRIM to allow the model's ailerons to be trimmed together as flaps at any time during the flight, with a maximum travel of 5% of the total flap travel set in FLAPERON.	Open FLAP-TRIM function	(MODE) to BASIC (MODE) again to ADVANCE (DIAL) to FLAP-TRIM.PUSH.
	The function is automatically activate with FLAPERON; however the default travel is 0.	
	Adjust the travel available to the FLAPERON when turning the CH6 dial.	(DIAL) to 5%
	Close	(END) (END)

### 3.3.5 AILE DIFF (ACRO/ GLID 2A+1F/ GLID 2A+2F)

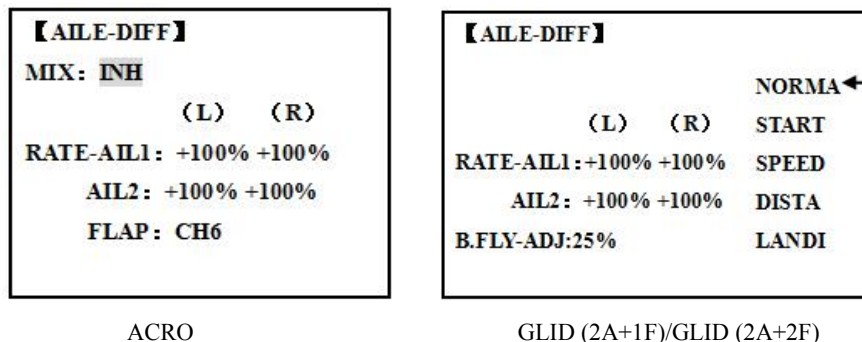

Aileron differential is primarily used on 3 or 4-servo wings, with one servo operating inboard flap on CH6 or CH5 & CH6, and AILE-DIFF controlling proper aileron operation of 2 aileron servos, plugged into CH1 and CH7. The ailerons can not be moved like flaps when using AILE-DIFF, except if using AIRBRAKE. (Note that even if you make FLAP-TRIM active while using AILE-DIFF, it will not have any effect. ONLY AIRBRAKE controls the ailerons as flaps in the AILE-DIFF configuration.)

☛ Note: When changing the polarity of a rate in camber-flap, "change rate dir?" is displayed for a check. Please set up after pressing DIAL for 1 second and canceling an alarm display. (GLID only)

- FLAPERON function allows you to set up 1 or 2 servos for flap action.
- The separate AILE-DIFF settings for each condition can be set. (GLID only)

Goals	Steps	Inputs
Activate twin aileron servos using AILE-DIFF. Note that the function defaults to no difference in down travel vs. up travel. If you want differential travel, simply adjust each side. (Ex: 90%)	Open the FLAPERON.	(MODE) to BASIC menu, (MODE) again to ADVANCE ( ) to AILE-DIFF .PUSH.
	Activate the function.	( ) to MIX,PUSH. ( ) to ACT
	Optional: adjust the up/down travel for 2 servos..(Ex:90% down)	( ) to AILE1 ( ) AILERON STICK. ( ) to 90% ( ) to AILE2, ( ) AILERON STICK, ( ) to 90%
	Close	(END) (END)

\*If you receive an error message that OTHER WING MIXING IS ON, you must deactivate ELEVON or FLAPERON.

### 3.3.6 Air Break (ACRO/ GLID)

[AIR-BRAK]	
AIL1: ---	MIX:INH
AIL2: ---	SW:SwC
FLAP:+ 50%	:DOWN
ELEV:- 10%	MODE:offset
-delay-	
ELEV: 0%	

ACRO

[BUTTERFLY]	
AIL1: 0%	MIX:INH
AIL2: 0%	SW:SwA
FLAP: 0%	:DOWN
SPOI: --	CRI: 1
PRESET: 15% (99%)	

GLID



Like FLAPERON and AILEVATOR, AIRBRAKE is one function that is really made up of a series of pre-programmed mixes all done for you within the radio. AIRBRAKE (often called "crow" or BUTTERFLY - see GLID, p. 62 for details) simultaneously moves the flap (if installed), twin ailerons (if installed) and elevator, and is usually used to make steep descents or to limit increases in airspeed in dives.

This function is often used even on models without flaps as an easy way to use the FLAPERON and FLAP-ELEVATOR mixing together.

ADJUSTABILITY:

- Activation: be proportional by moving the THROTTLE STICK, or set positions by flipping the assigned switch.
- Switch: Mix SWITCH is selectable.
- Also LOGIC SW (Lsw1 to 3) may be assigned.
- Linear(Inversely proportional to THROTTLE STICK): Provides a proportional increase in amount of AIRBRAKE action as THROTTLE STICK is lowered and assigned switch is on. It provides gradually more AIRBRAKE as you slow the engine. Includes selectable stick position where AIRBRAKE begins, gradually increasing to the same setting as the THROTTLE STICK is lowered. If you would like to have the airbrake be directly proportional to throttle stick, you will need to reverse the THR-REV function. Note that this changes the throttle stick direction for all models.
- Offset: Provide AIRBRAKE response immediately upon switch movement, going to a pre-set travel on each active channel without any means of in-flight adjustment.
- During Airbrake operation, the elevator travel is displayed on the elevator trim display in the Startup screen.
- Delayed reaction: You can suppress sudden changes in your model's attitude when AIRBRAKE BUTTERFLY is activated by setting the delay (delay-ELEV) item, to slow down the elevator response, allowing the flaps/aileron/elevator to all reach their desired end point together. A setting of 100% slows the servo to take approximately one second to travel the prescribed distance. (GLID: B.FLY-ELEV function)
- Adjustable in flight (ACRO): Using the aileron (when AILE-DIFF or FLAPERON is activated) and elevator trim lever in flight can be set to adjust the aileron and elevator settings in your airbrake rather than

adjusting the model's actual aileron and elevator trim. This allows easy adjustment for any ballooning while in flight. When the airbrake switch is moved to off the trim is again adjusting the normal elevator trim.

- Channels controlled: Elevator, twin ailerons and flap may be set independently in AIRBRAKE, including set to 0 to have no effect.
- If FLAPERON is active, the travel of the ailerons can be independently adjusted for the servos plugged into CH1 and CH6. The flap choice has no effect on the FLAPERON.
- If AIL-DIFF is active, then CH1 and CH7 may be independently adjusted.
- Normally both ailerons are raised equally in AIRBRAKE, and the elevator motion is set to maintain trim when the ailerons rise. Different amounts may be set for each aileron to correct for torque reactions and other unique characteristics of the model.
- ☛ Be sure you understand what dropping ailerons will do when in AIRBRAKE BUTTERFLY. Along with creating an enormous amount of drag (desirable for spot landings), this also creates "wash-in", a higher angle of attack where the ailerons are, and encourages tip stalling.

If you are using this for aerobatic performance and not "sudden stops", consider raising the ailerons and dropping the flaps instead as shown in the diagram above.

Goals	Steps	Inputs
Activate AIR-BREAK on a FLAPERON. Mode. Adjust the FLAPERON travel to 75%, with negative elevator(push) of 25%.	Confirm FLAPERON is active.	See FLAPERON instructions.
	Open AIR-BREAK.	(MODE) to BASIC . (MODE) again to ADVANCE (SW) to AIR-BREAK. PUSH.
	Activate the function	(SW) SW C in up position (SW) to MIX. PUSH (SW) to OFF
	Adjust the travels as needed. (Ex: Ailerons each 75%, Elevator-25%)	(SW) to AIL1.PUSH. (SW) to +75%,PUSH (SW) to ELEV.PUSH. (SW) to -25%,PUSH (SW) to AIL2.PUSH. (SW) to +75%,PUSH
	Optional: delay the speed of the elevator servo.	(SW) to delay-ELEV. PUSH. (SW) to 25%,PUSH
	Optional: change the mixing from full amount upon switch to proportional to the Throttle Stick's proximity to idle.	(SW) to MODE.PUSH. (SW) to Linear(0%),PUSH. (SW) Throttle Stick to desired 0 point.  (SW) for 1sec.till beeps  (Display changes if new setting is different from prior
	Close	(END) (END)

### 3.3.7 ELEV-FLAP mixing (ACRO/GLID):

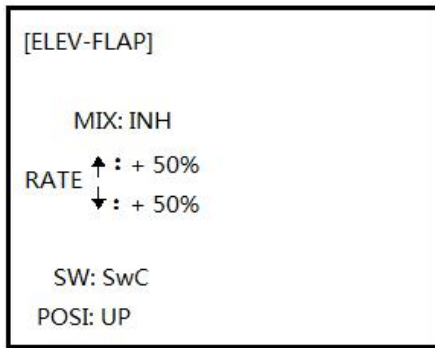

ACRO

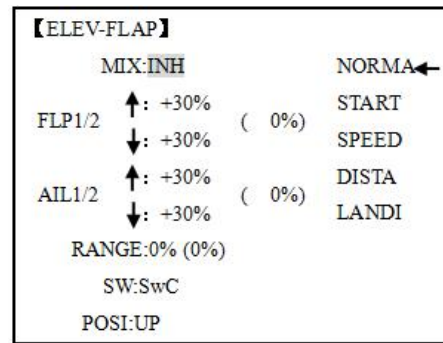

GLID

ELEV-FLAP mixing is the first pre-programmed mix we'll cover. This mix makes the flaps drop or rise whenever ELEVATOR STICK is moved. It is most commonly used to make tighter pylon turns or squarer corners in maneuvers. In most cases, the flaps droop (are lowered) when up elevator is commanded.

Adjustability:

- Rate: -100% (full up flap) to +100% (full down flap), with a default of +50% (one-half of the flap range is achieved when the ELEVATOR STICK is pulled to provide full up elevator.)
- Switch: Fully assignable. Also LOGIC SW (Lsw1 to 3) may be assigned. IF you set it to NULL, the mix does not work. (ACRO)
- Range (GLID): The range that mixing does not work near neutral of an elevator stick can be set up. Hold the stick to the desired point (upper or lower side) , then press DIAL and hold one second to set the range.
- Condition (GLID): The separate ELEV-FLAP settings for each condition can be set.

Goals	Steps	Inputs
Activate ELEV-FLAP mixing. Adjust flap travel to 0% flaps with negative elevator (push) and 45%flaps with positive elevator.	Open ELEV-FLAP	(MODE) to BASIC . (MODE) again to ADVANCE (DIAL) to ELEV-FLAP. PUSH.
	Activate the function	(DIAL) to MIX,PUSH. (DIAL) to ON.PUSH
	Adjust the travels as needed. (Ex:0%, to45%)	(DIAL) to RATE. (DIAL) Elevator Stick (DIAL) to 0%, (DIAL) (DIAL) Elevator Stick (DIAL) to +45%, (DIAL)
	Close	(END) (END)

### 3.3.8 Dual Elevator Servos (with a rudder) (AILEVATOR) (ACRO):

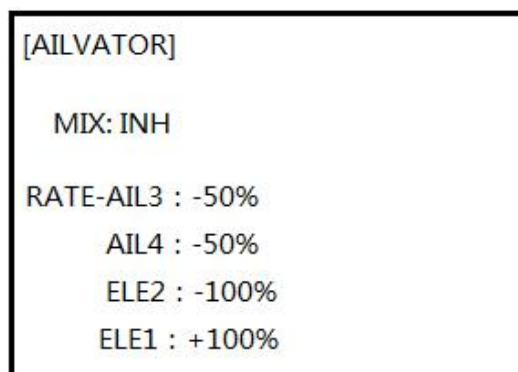

Many models use two elevator servos, plugged in separate receiver channels. (Flying wings without a separate aileron control use ELEVON. V-shaped tail models use V-TAIL, ADVANTAGE:

- Ability to adjust each servo's center and end points for perfectly matched travel.
- Ease of assembly, not requiring torque rods for a single servo to drive 2 surfaces.
- Elevators acting also as ailerons for extreme stunt flying or more realistic jet flying (optional).
- Redundancy, for example in case of a servo failure or mid-air collision.

**ADJUSTABILITY:**

- CH2 and CH8 only. (With programmable mixing, could utilize CH5 as the 2nd elevator servo. THROTTLE-NEEDLE uses CH8 and cannot be active simultaneously).
- Direction of each servo's travel may be reversed in REVERSE or the set percentages may be reversed here.
- Elevator travels independently adjustable (both directions and percent).
- Optional action as ailerons (defaults to 50% response). This response cannot be activated/ deactivated in flight. Setting AIL1 and 2 to 0 disables this feature.

☛ Note: if you want this, but on/off with a switch, set AIL1 and 2 to 0 here, and use 2 mixes. AIL-to-AUX2 (link/trim off, assign a switch), get aileron action from the elevator servos when the assigned switch is on. The AILEVATOR mixing function uses one servo on each of the two elevators, and combines the elevator function with the aileron function (unless aileron travel is set to 0). For aileron effect, the elevators are raised and lowered opposite of one another in conjunction with the ailerons.'

Once AILEVATOR is activated, unless you zero out the aileron figures (see below), any time you move your ailerons or any programming moves your ailerons (i.e. RUDDER-AILERON mixing), the radio automatically commands both elevator servos to also operate as ailerons. To deactivate this action, simply set the 2 aileron travel settings to 0 in the AILEVATOR function. This way the elevators will work only as elevators.

Goals	Steps	Inputs
Activate twin elevator servos. Deactivate the elevator-acting –as-aileron portion of this function. Note: depending upon your model's geometry, may need to reverse one servo or set a negative percentage here.	Open the AILEVATOR	(MODE) to BASIC . (MODE) again to ADVANCE ⊖ to AILVATOR, ⊕
	Activate the function.	⊖ to MIX,PUSH. ⊕ to ACT. ⊕
	Optional: adjust up/down travel when operating as ailerons. (Ex:0)	⊖ to AIL3,PUSH. ⊕ to 0%, ⊕ ⊖ to AIL4,PUSH. ⊕ to 0%, ⊕
	Optional: adjust total elevator travel of each servo. (Ex: right servo elevator travel to 98%,left to 96%)	⊖ to ELE2.PUSH ⊕ to 98%, ⊕ ⊖ to ELE1.PUSH. ⊕ to 96%, ⊕
	Close	(END) (END)

**3.3.9 Snap Rolls (ACRO)**

[SNAP-ROLL]	
	(1:R/U)
-rate-	MIX:INH
AIL1:+100%	SAFE-MODE:FREE
ELEV:+100%	DIR-SW1:NUL
RUDD:+100%	2:NUL

This function allows you to execute snap rolls by flipping a switch, providing the same input every time. It also removes the need to change dual rates on the 3 channels prior to performing a snap, as SNAP-ROLL always takes the servos to the same position, regardless of dual rates, inputs held during the snap, etc.

☛ Note: Every MULTIROTOR snaps differently due to its C.G., control throws, moments, etc. Some models snap without aileron; others snap on elevator alone. Most models snap most precisely with a combination of all 3 surfaces. Additionally, rate of speed and acceleration when using the snap switch will



affect how the model snaps. For information using gyros with airplanes for cleaner precision maneuvers, such as snaps and spins without over rotation.

**ADJUSTABILITY:**

- Travel: Adjust the amount of elevator, aileron and rudder travel automatically applied.
- Range: -120 to +120 on all 3 channels. Default is 100% of range of all 3 channels.
- Directions: Up to 4 separate snaps is fully adjustable regarding travels and direction on each of the 3 channels.

Note: for simplicity, the radio refers to snaps that use “UP” or positive elevator as “U” or “UP” snaps. This is more commonly referred to as a positive or inside snap. “D” or “DOWN” snaps are more commonly referred to as negative or outside snaps.

- R/U = Right positive R/D = Right negative L/U = Left positive L/D = Left negative snap roll.
- Assignment of the 2 switches (DIR-SW1/2) to change snap directions is fully adjustable and optional. If you wish to have only one snap, leave the switches as NULL. (If assigned, SW1=up/down, SW2=left/right)
- Safety Switch (SAFE-MOD): a safety may be set up on your landing gear SWITCH, preventing accidental snap rolls while the landing gear is down. The safety switch is turned on and off with the landing gear SWITCH.
  - ON: the safety mechanism is activated when the landing gear SWITCH is in the same position as at the time this feature is changed to ON. Snap rolls will not be commanded even if the snap roll SWITCH is turned on with the gear SWITCH in this position. When the landing gear SWITCH is moved to the opposite position, snap rolls may be commanded.
  - OFF: Activate the safety mechanism in the opposite position from the ON function.
  - FREE: The safety mechanism is completely turned off. Snaps can be commanded regardless of the gear SWITCH POSITION.
- Note: The location of the safety switch always follows channel 5. If channel 5 is reassigned to switch C, for example, switch C is now the safety. If channel 5 is null or used as the second aileron servo, the safety function will not be available.
- Trainer Safety: SNAP-ROLL is automatically disabled when the trainer function is activated.

Goals	Steps	Inputs
Activate SNAP-ROLL. Adjust elevator travel to 55%, rudder travel to 120% in the right/up snap. Activate SAFE-MODE so snaps can not be performed when gear is down. Adjust rudder travel in the left/down snap to 105%. (Note: using negative percents can change any of the 4snap directions. For example. change snap 1 to ‘down’ by changing the elevator percent to -100%)	Open SNAP-ROLL.	(MODE) to BASIC . (MODE) again to ADVANCE (SW1) to SNAP-ROLL, (SW2)
	Activate the function	(SW1) to MIX.PUSH (SW2) to OFF or ON. (SW3)
	Adjust the travel as needed. (Ex: elevator to 55%,rudder to 120%)	(SW1) to ELEV.PUSH. (SW2) to 55% (SW3) (SW4) to RUDD.PUSH . (SW5) to 120%, (SW6)
	Optional: Activate SAFE-MOD.(Ex: ON when Sw E or Sw G is down, meaning snap function is deactivate when that switch is in the down position)	(SW7) E or G to UP position (SW8) to SAFE-MODE.PUSH. (SW9) to ON. (SW10) (SW11) snap switch NOTE: MIX is OFF. (SW12) E or G to DOWN position. NOTE: MIX is ON.
	Optional: Assign switches up/down and left/right.(Ex: Change to the left/down snap and adjust rudder to 105%)	(SW13) to DIR-SW1.PUSH (SW14) to SwA (SW15) (SW16) to DIR-SW2.PUSH (SW17) to SwB, (SW18) (SW19) A down, B down Repeat steps above to set percentages.
Close	(END) (END)	

### 3.3.10 V-Tail (ACRO/ GLID)

V-TAIL mixing is used with v-tail MULTIROTOR so that both elevator and rudder functions are combined for the two tail surfaces. Both elevator and rudder travel can be adjusted independently on each surface.

<b>【V-TAIL】</b>
<b>MIX: INH</b>
<b>RATE-ELE1: +50%</b>
<b>ELE2: -50%</b>
<b>RUD2: +50%</b>
<b>RUD1: +50%</b>

⦿ Note: NOTE: If V-TAIL is active, you cannot activate ELEVON or AILEVATOR functions. If one of these functions is active, an error message will be displayed and you must deactivate the last function prior to activating ELEVON.

⦿ Note: Be sure to move the elevator and rudder sticks regularly while checking the servo motions. If a large value of travel is specified, when the sticks are moved at the same time, the controls may bind or run out of travel. Decrease the travel until no binding occurs.

Adjustability:

- Requires use of CH2 and CH4.
- Independently adjustable travels allow for differences in servo travels.
- Rudder differential is not available. (To create rudder differential, set RUD1 and 2 to 0, then use two programmable mixes, RUD-ELE and RUD-RUD, setting different percents for up and down. These are your new rudder travels. Trim and link off, switch assignment null so you can't accidentally turn off rudder.

### 3.3.11 ELEVON

<b>【ELEVON】</b>
<b>MIX: INH</b>
<b>(L) (R)</b>
<b>RATE-AIL1: +100% +100%</b>
<b>AIL2: +100% +100%</b>
<b>ELE2: -100%</b>
<b>ELE1: +100%</b>

ADJUSTABILITY:

- Requires use of CH1 and CH2.
- Independently adjustable aileron travel allows aileron differential.
- Independently adjustable elevator travel allows for differences in up vs. down travel.
- The separate ELEVON settings for each condition can be set. (GLID only)
- ⦿ Note: When changing the polarity of a rate, "change rate dir?" is displayed for a check. Please set up after pressing DIAL for 1 second and canceling an alarm display. (GLID only)
- ⦿ Note: Be sure to move the elevator and aileron sticks to full deflection during setup. If large travels are specified, when the AILERON and ELEVATOR STICKS are moved at the same time the controls may bind or run out of travel.

Goals	Steps	Inputs
Activate ELEVON. Adjust aileron down travel to 90% of up travel, creating aileron differential.	Open ELEVON	to BASIC .  again to ADVANCE to ELEVON,
	Activate the function.	to MIX, PUSH  to ACT.
	Optional: adjust up/down travel separately for the servos as ailerons.(Ex: down to 90%)	to AIL1.PUSH.  Aileron Stick.  to 90% to AIL2.PUSH.  Aileron Stick.  to 90%
	Optional: adjust the elevator travel of each servo.(Ex: right servos elev. Travel to 98%, left to 105%.)	to ELE2.PUSH.  to 98%. to ELE1.PUSH.  to 105%
	Close	

### 3.3.12 Gyro Sense

The gyros have two operations modes: GY mode and STD mode.

- STD mode: This mode performs general proportional control operation. For instance, it controls the gyro so that changes are countered when the attitude of the MULTIROTOR is changed by cross-wind, etc.
- GY mode: This mode performs both proportional and integrated control operation. The difference between Normal mode and GY mode operation is that where as the Normal mode only counters changes in attitude, the GY mode returns to the original controlled variable simultaneously with countering changes in attitude. For example, during knife edge flying, aileron and elevator meeting rudder is normally necessary, but in the GY mode, meeting rudder is performed automatically by the gyro.

[GYRO-SENSE]			
MIX-1:INH		2:INH	
UP	> 0%	> 0%	
CNTR	> 0%	> 0%	
DOWN	> 0%	> 0%	
CH:CH5		CH8	
SW:SwG		SwG	

Adjustability:

- Plug the gyro's sensitivity adjustment to channel 5, 7, or 8 of the receiver. (Selectable)
- Full switch assignable (SWITCH A-H)
- Each rate setting may be set from 0 to NOR100% or AVC100% gain. NOR: GY mode gain. AVC: STD mode gain
- Larger percentages indicate more gain, or gyro responsiveness.
- MIX-1,2: Two surfaces' sensitivity can be adjusted independently.

GYRO GAIN ADJUSTABILITY:

- When the servo hunts, the gyro gain is too high. Lower the gain until the hunting stops.
- The gyro will display best performance at a gain just before hunting occurs. Perform adjusting by flying the MULTIROTOR repeatedly.

⚠ Precaution:

- When taking off and landing, always switch to the Normal mode. Taking off and landing in the GY mode is dangerous.
- We recommend that you use the rudder control gyro in the Normal mode. In the GY mode, rudder operation is necessary when turning because the weather vane effect is lost. Use the gyro in the Normal mode unless you are an expert in rudder operation.
- And we recommend that you also set to off (0%) mode for safety as follows.

Goals	Steps	Inputs
Set up a GYA gyro setting (Ex:MIX-1)	Open GYRO-SENSE	(MODE) to BASIC . (MODE) again to ADVANCE ⊙ to GYRO-SENSE, ⊙
	Activate the function.	⊙ to MIX-1.PUSH ⊙ to ON. ⊙
	Optional: change switches assignment. Ex: select E.	⊙ to SW.PUSH. ⊙ to SwE ⊙
	Adjust gyro rates as needed.(Ex: UP to NOR70%,CNTR to 0%[off], DOWN to AVC70% as starting points.	⊙ to gyro rate. Push. ⊙ E up. ⊙ to NOR 70%, ⊙ E to CNTR, ⊙ to 0%, ⊙ E DOWN, ⊙ to AVC70%
Close		(END) (END)

### 3.3.13 THR-DELAY (ACRO):

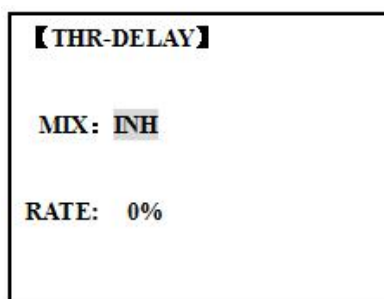

The THR-DELAY function is used to slow the response of the throttle servo to simulate the slow response of a turbine engine. A 40% delay setting corresponds to about a one-second delay, while a 100% delay takes about eight seconds to respond. This function may also be used to create a “slowed servo” on a channel other than throttle. This is accomplished by plugging the desired servo (Ex: gear doors) into CH3 (THR), throttle into an auxiliary channel such as 8, and then using some creative mixes.

Goals	Steps	Inputs
Activate THR-DELAY for a ducted-fan replica of a turbine-powered MULTIROTOR. Slow the servo response by one second.	Open THR-DELAY	(MODE) to BASIC . (MODE) again to ADVANCE ⊙ to THR-DELAY, ⊙
	Activate the function.	⊙ to MIX.PUSH. ⊙ to ACT. ⊙
	Adjust the RATE to match the desired servo speed.(Ex:40%)	⊙ to RATE.PUSH ⊙ to 40% ⊙
	Close	

### 3.3.14 THR CURVE (ACRO)

This function adjusts the throttle operation curve for optimum the engine speed to throttle stick movement.

☛ Note: If the throttle EXP function is activated, you can not use THR-CURVE function simultaneously.

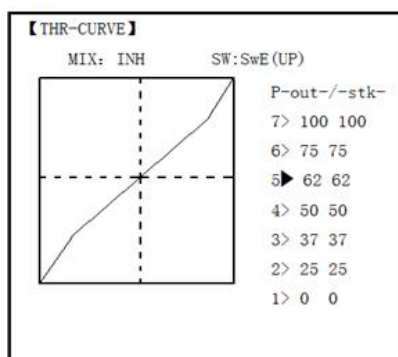

Adjustability:

- Separate curves for each switch position are available.
- Moving and deleting the curve point: The curve point (-STK-) can be moved to the left or right by turning the DIAL (up to 2% in front of the adjoining point) and deleted/returned by pressing the DIAL for one second alternately.

Goals	Steps	Inputs
Base point: Adjust base point of throttle curve until engine idles reliably. -Out-:output,servo position. -STK-: curve point, stick position.	Open THR-CURVE	(MODE) to BASIC . (MODE) again to ADVANCE (DIAL) to THE-CURVE, (DIAL)
	Activate the function.	(DIAL) to MIX.PUSH (DIAL) to ON. (DIAL)
	Adjust the 1 <sup>st</sup> point	(DIAL) to P1(-out-).PUSH (DIAL) to desired servo position
	Optional: assign the switch.	(DIAL) to SW.PUSH. (DIAL) to desired switch.
	Optional: Move the curve point.(Ex: point 3)	(DIAL) to P3 (-stk-),PUSH (DIAL) to desired curve point to move to left or right.
	Optional: delete the curve point. And return the curve point.(Ex: point 3)	(DIAL) to P3 (-stk-). (DIAL) for 1 sec.to delete the curve point. (DIAL) to P3 (-stk-), (DIAL) for 1 sec.to return
	Adjust the next point.	Repeat as needed.
	Close	(END) (END)

### 3.3.15 THROTTLE-NEEDLE mixing (ACRO/ HELI):

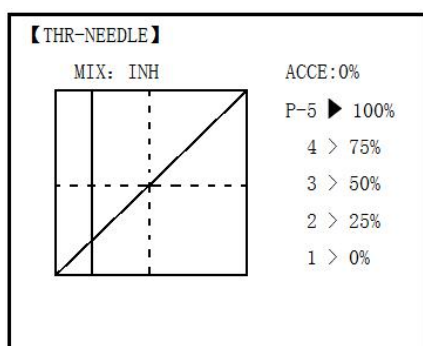

ACRO

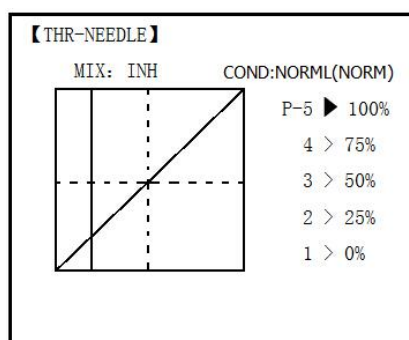

HELI

THROTTLE-NEEDLE is a pre-programmed mix that automatically moves an in-flight mixture servo (CH8) in response to the THROTTLE STICK inputs for perfect engine turning at all throttle settings. This function is particularly popular with contest pilots who fly in a large variety of locations, needing regular engine tuning adjustments, and requiring perfect engine response at all times and in all maneuvers. Also popular to

minimize flooding at idle of inverted engine installations or installations with a high tank position. Not needed for fuel injection engines, which do this automatically.

**ADJUSTABILITY:**

- Five-point curve allows adjustment of engine mixture at varied throttle settings.
- The in-flight mixture servo must connect to receiver CH8.
- In-flight mixture servo may also be used as a second servo for tuning a twin.
- Throttle cut feature also moves the in flight needle servo.
- The CH8 knob adjusts the high throttle mixture (may be deactivated. see AUX-CH).
- Because both use CH8, this function cannot be used simultaneously with AILEVATOR.
- An acceleration (ACCE) function (ACRO only) helps the engine compensate for sudden, large amounts of throttle input by making the mixture suddenly richer, then easing it back to the proper adjustment for that throttle setting. This function requires some adjustment to best fit your engine and your flying style. Adjust engine's response until no hesitation occurs on rapid throttle input.
- Separate curves are available (HELI only) for normal, idle-ups 1 and 2 combined, and idle-up 3. Immediately below MIX the radio displays the curve you are editing; ex: >NORML; and then which condition is currently active by your switches ex: (ID1/2). Note that you can edit the mix for a different condition without being in that condition, to allow editing without having to shut off the helicopter's engine every time. Be sure you are editing the proper curve by checking the name after the > and not the one in parentheses.

Goals	Steps	Inputs
Activate THROTTLE-NEEDLE mixing. Adjusting the points as follows: to resolve a slight lean midrange problem: 1: 40% 2: 45% 3: 65% 4: 55% 5: 40%	Open THROTTLE-NEEDLE	to BASIC .  again to ADVANCE to THR-NEEDLE,
	Activate the function.	to MIX.PUSH  to ON.
	HELI only. Select the condition to edit.	to COND.PUSH.  as needed.
	Adjust the travels as needed to match your engine by slowly moving the stick to each 5 points, then adjusting the percentage at that point until the engine is properly tuned.	to PIONT. to P 1,  to 40%, to P 2,  to 45%, to P 3,  to 65%, to P 4,  to 55%, to P 5,  to 40%,
	ACRO only . Optional: increase mixture when throttle is applied rapidly-ACCE.(see above for details)	to ACCE. Push  Throttle Stick to idle Throttle Stick to full open quickly.
	Heli only: set curves for another conditions.	to condition name  to next condition name to edit. Repeat above steps as needed.
	Close	

## PART 4 GLIDER MODEL FUNCTIONS

Please note that nearly all of the BASIC menu functions are the same for airplane (ACRO setup), sailplane (GLID 1A+1F/ 2A+1F/ 2A+2F setups), and helicopter (HELI setups). The features that are identical refer back to the ACRO chapter. The glider BASIC menu includes MOTOR CUT and does not include IDLE-DOWN or THR-CUT.

⊖Note: in all cases where ACRO programming labels channel 3 as throttle, GLID programming labels channel 3 as ARB (airbrake), since airbrakes are normally operated on channel 3 in gliders. This includes STK-THR reading STK-ARB.

### 4.1 SET BASIC MENU OF GLID

This guideline is intended to help you get acquainted with the radio, to give you a jump start on using your new radio, and to give you some ideas and direction in how to do with this powerful system.

Goals	Steps	Inputs
Prepare your airplane.	Install all servos, switches, receiver per your model's instructions. Turn on transmitter then receiver; adjust all linkages so surfaces are nearly centered. Mechanically adjust all linkages to get as close as possible to proper control throws and minimize binding prior to radio set up. Check servo direction and throws. Make notes now of what you will need to change during programming.	
Select the proper MODEL TYPE for your model. (Ex: GLID 1A+1F) [NOTE: This is one of several functions that require confirmation to make a change. Only critical changes such as a MODEL RESET require additional key strokes to accept the change.]	In the BASIC menu, open PARAMETER submenu.	Turn on the transmitter. (MODE) for 1 sec. to BASIC.(If ADVANCE (MODE) again.) (MODE) to choose PARAMETER. (MODE)
	Choose proper MODEL TYPE. Ex: GLID (1A+1F). Confirm the change. Close submenu.	(MODE) to MODEL TYPE (MODE), (MODE) to GLID(1A+1F) (MODE) for 1 sec. Are you sure? Displays. (MODE) to confirm. (END) Return to BASIC menu.
Name the model Note that you do not need to do anything to 'save' or store this data.	In BASIC menu open the MODE SEL submenu.	(MODE) to MODEL SEL. (MODE), (MODE) to NAME. (1 <sup>st</sup> character of model's name is highlighted) .
	Input airplane name. Close the submenu.	(MODE) to change the 1 <sup>st</sup> character. (MODE) to confirm. (MODE) to next character and repeat. (END) to return.
REVERSE servos as needed for proper control operation.	In the BASIC menu, open REVERSE.	(MODE) to REVERSE. (MODE)
	Choose desired servo and reverse its direction of travel. (Ex: reverse rudder servo.)	(MODE) to 4.RUDD, (MODE) REV is highlighted. (MODE) for 1 sec. 'Are you sure?' Displays. (MODE) to confirm. (END) To BASIC menu.
Adjust travels as needed to match model's recommended	In BASIC menu choose END POINT.	(MODE) to END POINT. (MODE)

	Adjust the servos' end points. (Ex: flap servo). Close the function.	to FLAP VR(A)   to desired travel. VR(A)   to desired travel. Repeat as needed.
	Choose D/R,EXP	to D/R,EXP
Set up dual/triple rates and exponential (D/R, EXP).  <i>(Note that in the middle of the left side of the screen is the name of the channel and the SWITCH position you are adjusting. Two or even three rates maybe set per channel by simply choosing the desired SWITCH and programming percentages with the SWITCH in each of its 2/3 position.)</i>	Choose the desired control, and set the first (Ex: high) rate throws and exponential.	to CH   to CH2(ELEV). A to UP position. Screen reads ELEV [UP]  to D/R  Elevator Stick.   to set . Elevator Stick.  to set . (Normally the same for both direction)  to EXP Elevator Stick  to set Elevator Stick  to set
	Set the second (Ex: low) rate throws and exponential.	to D/R   A to down position. Repeat above to set low rate.
	Optional: change dual rate SWITCH assignment. Ex: elevator to SWITCH G with 3 positions.	to SW   to G,  G to center. Repeat steps above to set 3rd rate. <b>END</b>
Move flap control from the (VR (A)) dial to the left slider. [VR(D)](AUX-CH) .	In the BASIC menu, open AUX-CH.	to AUX-CH
	Choose CH5. Change primary control to VR(D). Change other channels as needed.	to CH5   to VR(D). Repeat steps above to set other channels.
	Close	<b>END</b> <b>END</b>

## 4.2 SET GLID TYPE

TYPE: (GLID 1A+1F), GLID (2A+1F), GLID (2A+2F)

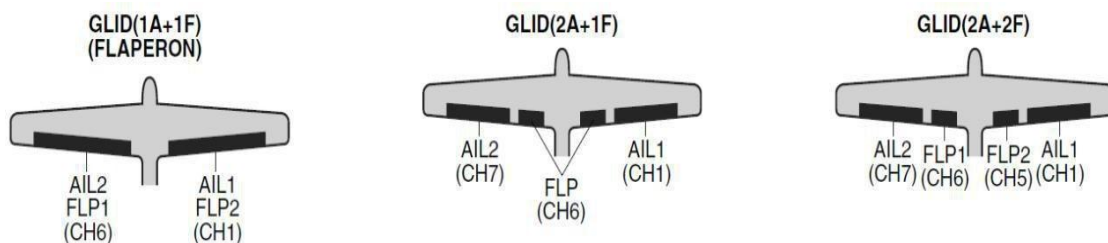

Before doing anything else to set up a glider or sailplane, first you must decide which MODEL TYPE best



fits your MULTIROTOR.

- **GLID(1A+1F)**: The GLID (1A+1F) MODEL TYPE is intended for sailplanes with one or two aileron servos (or none), and a single flap servo (or two connected with a y-connector). This TYPE is meant to be a very simplistic version to set up a basic glider without a lot of added features. Additional flight condition is available.
- **GLID (2A+1F)**: The GLID (2A+1F) MODEL TYPE is intended for sailplanes with dual aileron servos and a single flap servo (or two connected with a y-connector). Additional flight conditions are available. These flight conditions contain different offset trims and aileron differentials to make the sailplane perform certain maneuvers more easily.
- **GLID (2A+2F)**: The GLID (2A+2F) MODEL TYPE supports dual flap servos that can also act as ailerons, creating full-span ailerons and flap. Additional flight conditions are available. These flight conditions contain different offset trims and aileron differentials to make the sailplane perform certain maneuvers more easily.

### **4.3 GLID ADVANCE MENU**

MIXES:

- **Linear Programmable mixes (PROG.MIX1-4)**: Fully assignable programmable mixed with a linear response.
- **Curved Programmable mixes (PROG.MIX5-8)**: Fully assignable programmable mixed with a curved response.
- **ELEV-FLAP** pre-programmed mix creates elevator movement from the inboard flaps as well as elevators.
- **BUTTERFLY**: Often called crow, BUTTERFLY is the glider version of AIRBRAKE. (BUTTERFLY does not have the option to activate it solely from a switch, and its activation switch. It always provides progressively more BUTTERFLY as the CHANNEL 3 (THROTTLE) STICK is lowered, or raised if used THR-REV) See AIRBRAKE.
- **CAMBER-MIX AILE-FLAP**: This pre-programmed mix is used to create full span flap/aileron action on a glider with 4 wing servos. This changes the camber over the entire wing, which produces less drag than just dropping the flaps by themselves.

⊖ Note: When you have ELEV-FLAP mixing also, the trailing edge droops with the elevators, increasing pitch response.

- **FLAPERON (GLID 1A+1F only)**: 2 aileron servos operate in opposite directions as ailerons and same direction as flaps.
- **CAMBER FLAP**: Provides camber movement or trimming of flaps. For sailplanes, this function is also used as wing camber. The amount depends on the model but usually a small amount (less than 10%) is preferred, since too much camber produces excess drag. Don't use more than about 1/16" travel up or down for glider camber. Some airfoils, such as the RG15, should be flown with NO reflex/camber. Be sure to consult your model's manual for guidelines.

⊖ Note: even though you may make CAMBER FLAP active while using AILE-DIFF, it will not have any effect. The ONLY function that allows control of the ailerons as flaps in the AILE-DIFF configuration is airbrake/ butterfly

- **ELEVON**: for flying wings
- **V-TAIL**: For models with 2 servos operate together to create roll and pitch control.
- **AILEVATOR**: Not available in GLID model types.

#### **4.3.1 AILE DIFF (FIND IN ACRO FUNCTION MENU 3.3.5)**

#### **4.3.2 FLAPERON (GLID 1A+1F, FIND IN ACRO FUNCTION MENU 3.3.3)**

#### **4.3.3 V-TAIL (FIND IN ACRO FUNCTION MENU 3.3.10)**

#### **4.3.4 OFFSET (GLID 2A+2F):**

Additional flight conditions are available specifically for sailplanes.

【OFFSET】		
-rate-	-dly	NORMA←
ELEV: --%	0%	START
RUDD: --%	0%	SPEED
		DISTA
FLAP:--%	0%	LANDI

These additional flight conditions contain different offset trims to make the sailplane perform certain maneuvers more easily. Aileron differential functions may be set to provide separate rates per condition selected.

Prior to setting up OFFSET, you must active the conditions and assign the switches in the CONDITION/FUNCTION.

Unnecessary fuselage motion is generated when there are sudden changes in the servo position and variations in the operating time between channels can be suppressed by using the delay function.

• Note: The same delay amount for elevator and rudder is recommended when using V-tail function.

The AT9S provides 5 additional setups along with the normal flight condition. (NORMAL, START, SPEED, DISTANCE and LANDING) These offset trims have same setting abilities basically except the switch and dial assignment. For an example of trim settings, please see the following:

ADJUSTABILITY:

- Separate adjustments for each aileron, elevator, rudder and flap servo, for each condition.
- SWITCH G (AT9S) or E (AT9S) is programmed for NORMAL, START, and SPEED trims. SWITCH C is programmed for DISTANCE and LANDING trims. These switch/position assignment is adjustable.

(CONDITION/FUNCTION)

- TRIM item (Digital trim operation mode):

NORM: normal trim operation mode.

MIX: offset rate trim operation mode while mixing is on.

- Optional assignable knob (CAMBER MIX) to allow trimming in flight of the aileron and flap action of each flight condition.
- During OFFSET operation, the aileron and elevator travels are displayed on each trim display in the Startup screen.

Goals	Steps	Inputs
Set up a START to gain maximum possible lift on launch. Each Aileron: 50%. Each Flap: 100%. Elevator: -5% to compensate. SWITCH (AT9S=G, AT9S=E.) Note: switch is assignable. (CONDITION) KNOB(null) Note: knob is assignable. (CAMBER MIX)	Open OFFSET function	MODE to BASIC . MODE again to ADVANCE DIAL to OFFSET, DIAL
	Switch to the START condition.	G or E from NORMA to START
	Set the rates. (Ex: AIL 50%, FLP 100%, ELEV -5 %.)	DIAL to AIL DIAL, DIAL to 50%, DIAL Repeat for FLP and ELEV.
	Close	END END

#### 4.3.5 START DELAY (GLID 1A+1F only):

START DELAY automatically switch the offset trims (OFFSET) from the START condition's trims to the normal condition's trims after proceeding the delay time (max.10sec.) which is set by the -DLY- item when activating the START condition. (It is convenient for hand launch glider.)

• Note: The same delay amount for elevator and rudder is recommended when using V-tail function.

ADJUSTABILITY:

- Delay time (-DLY-) range of 0 to 100%. The delay time is 10 second at 100%.

**【START-DLY】**

MIX: **INH**

-dly-

ELEV: 5%

RUDD: 5%

AILE/FLAP: 5%

Goals	Steps	Inputs
Ex: delay time=5 second.	Open ADVANCE menu, then open START DELAY.	(MODE) to BASIC . (MODE) again to ADVANCE [DIAL] to START-DLY, [DIAL]
	Activate the function	[DIAL] to MIX [DIAL], [DIAL] to OFF or ON
	Set the delay time. (Ex:50% each surface)	[DIAL] to ELEV [DIAL], [DIAL] to 50% [DIAL] to RUDD [DIAL], [DIAL] to 50% Repeat as needed.
	Close	(END) (END)

#### 4.3.6 CHAMBER-FLP

CAMBER FLAP assigns the primary flap control [defaults to VR (A)] to allow trimming in flight of the flap action. The up and down travel of each flap (camber flaps: FLP1/2) can be adjusted independently. Also the center position of flap servo can be offset.

- Note: If FLAP-TRIM is activated, you can not use CAMBER FLAP function simultaneously.

**【CAMBER-FLAP】**

FLP1    ↑: +10%        (ON)

          ↓: +10%        (VrA:+63%)

FLP2    ↑: +10%

          ↓: +10%

CENTER : 0%

#### ADJUSTABILITY

- Rate: -100% to +100%, with a default of +30%
- Center position (CENTER): The operation reference point of flap can be offset. -100% to +100%, with a default of 0%.
- Note: When changing the polarity of a rate, "change rate dir?" is displayed for a check. Please set up after pressing DIAL for 1 second and canceling an alarm display.

Goals	Steps	Inputs
	Open the CAMBER FLAP function.	(MODE) to BASIC . (MODE) again to ADVANCE [DIAL] to CAMBER-FLP, [DIAL]

	Adjust the up/down trim amount separately.(Ex: adjust to 35%)	to FLP VR (A),  to 35%, VR (A),  to 35%, Repeat.
	Or: adjust the center position of flap servo	to CENTER ,  to desired point.
	Close	

### 4.3.7 Camber Mixing:

This function adjusts the mixing rate of camber operation which operates the wing camber (ailerons and flaps) in the negative and positive directions. The aileron, flap, and elevator rates can also be adjusted independently and attitude changes caused by camber operation can be corrected. Also the operation reference point of camber control can be offset. (PRE)

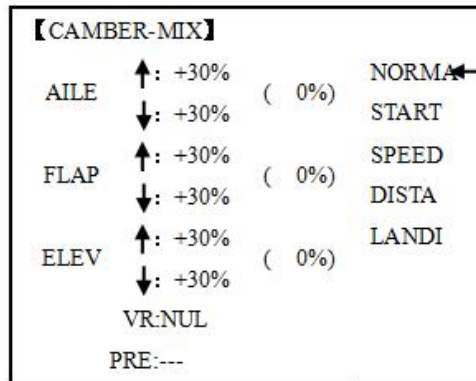

⊖ Note: Camber control is not assigned at initial.

#### ADJUSTABILITY:

- Rate: -100% to +100%, with a default of +30%
- Reference point (PRE): The operation reference point of camber control can be offset. -100% to +100%, with a default of 0%.

Goals	Steps	Inputs
Ex: set the mixing amount for aileron to 40%, camber control to VR (E), reference point to desired point.	Open the CAMBER MIX function.	to BASIC .  again to ADVANCE to CAMBER-MIX,
	Choose desired slider.	to VR ,  to VrA
	Adjust the mixing amount for AILE. (Ex: adjust to 40%)	to FLP to VrA ,  to 40%, to VrA ,  to 40%,
	Set the reference point.	to PRE ,  or  VrA to desired point  for 1 sec.
	Close	

### 4.3.8 BUTTERFLY (crow) mixing

<b>[BUTTERFLY]</b>	
<b>AIL1:</b> 0%	<b>MIX:INH</b>
<b>AIL2:</b> 0%	<b>SW:SwA</b>
<b>FLAP:</b> 0%	<b>:DOWN</b>
<b>SPOI:</b> --	<b>CRI: 1</b>
<b>PRESET: 15% (99%)</b>	

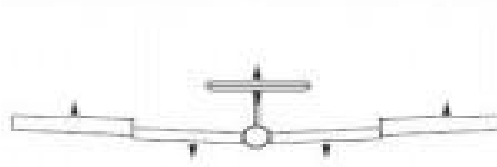

BUTTERFLY simultaneously moves the flaps, twin ailerons and elevator, and is usually used to make steep descents or to limit increases in airspeed in dives. Separate two BUTTERFLY settings are available. (CRI1/CRI2) ADJUSTABILITY:

- Activation: Get proportional by moving the THROTTLE STICK.
- Switch: Mix SWITCH is selectable. A to H: SWITCH A to H. Also LOGIC SW (Lsw1 to 3) may be assigned.
- NULL: always on.
- Inversely proportional to THROTTLE STICK: provides a proportional increase in amount of airbrake action as THROTTLE STICK is lowered (when SWITCH A (assignable) is in down position). Includes selectable stick position where airbrake begins. If you would like to have the airbrake be directly proportional to throttle stick, you will need to reverse the THR-REV function.
- ➔ Note: this changes the throttle stick direction for all models.

#### INSTRUCTIONS:

- Elevator settings: (Adjustable in the B.FLY-ELE)
- B.FLY-ELE works linking with BUTTERFLY function. Elevator rate is adjustable in a 3 point curve.
  - Point 1: PRESET point. (Fixed)
  - Point 2: MID point. Position and rate are adjustable.
  - Point 3: END point. Position and rate are adjustable.
- Delayed reaction: You can suppress sudden changes in your model's attitude when BUTTERFLY is activated by setting the delay (DELAY) item, to slow down the elevator response, allowing the flaps/ailerons/elevator to all reach their desired end point together. A setting of 100% slows the servo to take approximately one second to travel the prescribed distance.
- Channels controlled: Twin ailerons, flap and spoiler may be set independently in BUTTERFLY, including set to 0 to have no effect.
- Twin aileron servos: If AIL-DIFF function is inhibited, then AIL1 and AIL2 settings will have no effect. If AIL-DIFF is active, then CH1 and CH7 may be independently adjusted.
- Normally both ailerons are raised equally in BUTTERFLY, and the elevator motion is set to maintain trim when the ailerons rise. Different amounts may be set for each aileron to correct for torque reactions and other unique characteristics of the model.

Be sure you understand what dropping ailerons will do when in BUTTERFLY. Along with creating an enormous amount of drag (desirable for spot landings), this also creates "wash-in", a higher angle of attack where the ailerons are, and encourages tip stalling. If you are using this for aerobatic performance and not "sudden stops", consider raising the ailerons and dropping the flaps in stead as shown in the diagram above.

Goals	Steps	Inputs
Activate BUTTERFLY. Adjust the aileron and flap travel to 75% Elevator setting is adjustable in the B.FLY-ELE. MIX switch is selectable	Open the BUTTERFLY function	(MODE) to BASIC . (MODE) again to ADVANCE (MODE) to BUTTERFLY, (MODE)
	Activate the function	(MODE) SWA to UP position (MODE) to MIX (MODE), (MODE) to OFF (MODE)

	Adjust the travels as needed. (Ex: Aileron each 75%, Flap 75%)	to AIL1  to 75%,  to 75%, to FLP  to 75%,  to 75%, to AIL2  to 75%,  to 75%
	Close	

### 4.3.9 AILE/ RUDD MIX

<b>【AIL/RUD-MIX】</b>		
MIX:INH		NORMA ←
	(L) (R)	START
RATE: 0% 0%		SPEED
MODE: AILE → RUDD		DISTA
SW: SwA		LANDI
POSE: NULL		

You can select a pre-programmed mix which is used to mix the rudders with aileron operation or the ailerons with rudder operation.

Aileron-to-rudder mix (AILE RUDD): automatically creates a "coordinated turn".

Rudder -to-aileron mix (RUDD AILE): used to counteract undesirable roll (roll coupling) that happens with rudder input, especially in knife-edge.

ADJUSTABILITY:

- RATE range of -100 to +100. Negative setting would result in opposite rudder (aileron) action from aileron (rudder).
- SWITCH A-H fully assignable. Also LOGIC SW (Lsw1 to 3) may be assigned.
- POSITION fully assignable, including NULL (mix always on) and Up&Cntr and Cntr&Dn to activate the mix in 2 separate positions of the same SWITCH.
- Condition: The separate AILE RUDD setting for each flight condition can be set.

Goals	Steps	Inputs
Ex:RUDD-AILE, 25%,no switch, corrects roll coupling.	Open AIL/RUD-MIX submenu.	to BASIC .  again to ADVANCE to AIL/RUD-MIX,
	Select the mixing mode.	to MODE ,  to RUDD-AILE
	Activate the function	to MIX ,  to ON
	Set the rate (Ex:100% each way)	to RATE RUDDER STICK ,  to +25% RUDDER STICK ,  to +25%
	Close	

### 4.3.10 ELEV-FLAP mixing (see GLID menu 3.3.7)

### 4.3.11 AILE-FLAP(GLID 2A+2F only):

This pre-programmed mix is used to create full span aileron action on a glider with 4wing servos. This increases the roll rate and decreases induced drag. For normal flying, a value of about 50% is often used. For slope racing or F3B models in speed runs, you may wish to use a larger value approaching 100%.

ADJUSTABILITY:

- RATE range of -100 to +100. Negative setting would result in opposite aileron action from flaps.

- SWITCH A-H fully assignable. Also LOGIC SW (Lsw1 to 3) may be assigned.
- POSITION fully assignable, including NULL (mix always on) and Up&Cntr and Cntr&Dn to activate the mix in 2 separate positions of the same SWITCH.
- Condition: The separate AILE-FLAP settings for each flight condition can be set.

Goals	Steps	Inputs
Turn on AILE-FLAP mixing. Set rate to 100% for maximum possible flap travel with ailerons. Assign to SWITCH C center.	Open AILE-FLAP submenu.	(MODE) to BASIC . (MODE) again to ADVANCE ⊙ to AILE-FLAP, ⊙
	Activate the function	⊙ to MIX ⊙, ⊙ to ON
	Set the rate (Ex:100% each way)	⊙ to FLP1 ⊙ AILERON STICK ⊙, ⊙ to 100% ⊙ AILERON STICK ⊙, ⊙ to 100% Repeat above to set FLP2
	Assign the SWITCH and position.	⊙ to SW ⊙, ⊙ to SwC ⊙ to POSI ⊙, ⊙ to UP
	Close	(END) (END)

#### 4.3.12 SPOILER MIX (GLID):



















Moves the spoiler by flipping the assigned switch and is used to make steep decent. SPOILER MIX works linking with BUTTERFLY MIX.

[SPOILER-MIX]	
-SPO1-	-SPO2-
POSI :-50% ←	-50% ←
:+50%	+50%
CH :CH8	NULL
-rate-	-dly-
ELEV : 0%	0% (INH)
MIX : INH	
SW : SwE	POSI : DOWN

#### ADJUSTABILITY:

- Position: -100% to +100%, with a default of -50% (off), +50% (on)
- Channel: Spoiler 1: ch8, or 3 (ch8 or 3\*), Spoiler 2: NULL, or 3 (NULL or ch3\*) \*GLID (2A+2F) mode.
- Elevator setting: Rate: -100% to +100%, Delay: 0% to 100%
- SWITCH A-H fully assignable. Also LOGIC SW (Lsw1 to 3) may be assigned.

Goals	Steps	Inputs
2-servo spoiler mode. Adjust the spoiler servo position to 60%	Open the SPOILER MIX function and move to 2 <sup>nd</sup> page.	(MODE) to BASIC . (MODE) again to ADVANCE ⊙ to SPOILER - MIX, ⊙
	Activate the function.	⊙ to MIX ⊙, ⊙ to ON. ⊙
	Assign the SPO2-CH.(Ex: CH3)	⊙ to -SPO2- CH ⊙, ⊙ to CH3, ⊙

Adjust the spoiler servo position. (Ex: SPO1/SPO2=+55% to +60%)	 to -SPO1-POSI to -50%,  ,  to 60%,   to -SPO2-POSI to +50%,  ,  to 60%, 
Optional: Set the elevator rate. (Ex: 10%)	 to -rate- ELEV  ,  to 10%, 
Optional: set the delay. (Ex: 25%)	 to -dly- ELEV  ,  to 25%, 
Close	 

#### 4.3.13 FLAP-TRIM (see GLID 3.3.4)

#### 4.3.14 CONDITION

Channel 3's function is selectable in the ARBK-FUNC item. (Throttle stick, switches, or knobs) By choosing except STK, channel 3's function may be separated from Butterfly's function, so channel 3 can be used for other functions.

ADJUSTABILITY:

- Channel 3's function:

STK: THROTTLE STICK

Sw-A to H: SWITCH A to H

Vr-A to Vr-E: KNOB A to E

[CONDITION]		
	-sw-	-pos-
START:INH	SwE	DOWN
SPEED:INH	SwE	UP
DISTANCE:INH	SwC	CENT
LANDING:INH	SwC	DOWN
ARBKFUNC:ST-THK		



## Part. 5 HELICOPTER MODEL FUNCTIONS

Please note that nearly all of the BASIC menu functions are the same for airplane (ACRO setup), sailplane (GLID setups), and helicopter (HELI) setups. The features that are identical refer back to the ACRO chapter.

### 5.1 BASIC SETTING WITH HELICOPTER

This guideline is intended to help you set up a basic (H-1) helicopter, to get acquainted with the radio, to give you a jump start on using your new radio, and to give you some ideas and direction on how to do even more with this powerful system than you may have already considered.

Briefly, the typical helicopter's controls are as follows:









- Aileron: Changes cyclic lateral (roll). Roll the helicopter. Tilt the swash plate to the left or right CH1.
- Elevator: Changes cyclic pitch. Change the helicopter's angle of attack (nose up or nose down). Tilt the entire Swash plate fore and aft. CH2.
- Rudder: Change the angle of the tail rotor and yaw the helicopter left or right. CH4.
- Collective Pitch: Adjusts main rotor collective [angle of the paddles], changing the main blades' pitch. Increased collective pitch (with throttle) causes the helicopter to rise. Moves in conjunction with throttle on the THROTTLE STICK. CH6.

• Throttle: Open/close carburetor. Move in conjunction with collective pitch on the THROTTLE STICK. CH3.

• REVO: mix that adds rudder in conjunction with pitch. This helps compensate for rotation of the helicopter caused by the increased engine torque. (Never use REVO. mixing with a heading0hold/AVCS gyro; the gyro already does this.)

Goals	Steps	Inputs
Prepare your helicopter.	Install all servos, switches, receiver per your model's instructions. Set all trims, dials and sliders to neutral. Confirm all control linkages are 90 degrees (or per instructions ) from the servo horn to the ball link for proper geometry and that no slop is present. Mechanically adjust all linkages to get as close as possible to proper control throws and minimize binding prior to radio set up.	
Select proper mode type for your model. Ex: HELI H-1	In the BASIC menu, find PARAMETER.	for 1s to BASIC.(If ADVANCE  again) . to PARAMETER ,PUSH
	Go to MODEL TYPE.	to MODEL TYPE, then to TYPE.
	Select proper mode type. Ex: HELI H-1. Confirm the change. Close.	to HELICOPTER.  for 1 sec. 'Are you sure?' displays ,  to SWASH ,  to H-1  for 1sec,'Are you sure ??' displays.  to confirm.
Then , NAME the model.	In the BASIC menu, find PARAMETER.	to MODEL SEL.
	Go to MODEL SEL.-NAME	to Name(1 <sup>st</sup> character is highlighted)
	Input name.	to change the first character.
	Close the submenu when done.	When proper character is display.  to next. Repeat.

Goals	Steps	Inputs
Reverse servos as needed for proper control operation. Ex: Left Rudder Stick results in leading edges of tail rotor blades moving left. Reverse to operate properly.	In BASIC menu, open Reverse.	<b>MODE</b> for 1s to BASIC.(If ADVANCE <b>MODE</b> again) .
	Choose desired servo and reverse its direction of travel. Ex: reverse rudder servo.	<b>CH4:RUDD</b> , <b>REV</b> is highlighted. ‘Are you sure ?’ displays for 1 sec.
Adjust travels as needed to match model’s recommended throws.(usually listed as high rates.	In BASIC menu, choose END POINT.	<b>END POINT</b> to choose end point.
	Adjust the servo’s end points. (Ex: elevator servo). Return to BASIC menu.	<b>ELEV.</b> Elevator Stick , until up travel is as desired. Elevator Stick , until down travel is as desired. Repeat as needed. <b>END</b>
Activate THR-CUT.	Open THROTTLE-CUT function.	<b>THR CUT</b>
	Activate the function. Choose desired switch and position to activate.	<b>MIX</b> , <b>OFF</b> , <b>SW</b> , <b>SwC</b> , <b>POSI</b> , <b>DOWN</b> ,
	With THROTTLE STICK at idle, adjust the rate until the engine consistently shuts off, but throttle linkage is not binding. Close	<b>SwC</b> to down position, <b>Throttle Stick</b> , to <b>RATE</b> , until shuts off.
Set up throttle curve for normal. (Usually changes will not need to be made prior to first flight.)	Open the THR-CURV/NOR function. Adjust if needed. Close the function.	<b>THR-CURVE</b> , <b>COND:NORM</b> , to point 1> , to 5% , . Move to
Set up collective pitch curve for normal as base of -4, center of +5, end of +8 to +10 degrees of blade pitch for aerobatics.2 (If just learning to fly, ask your instructor.)	Open the PIT-CURV/NOR function. Adjust each point to desired Curve. (Ex: first Point:8%) Close the function.	<b>PIT-CURVE</b> , <b>COND:NORM</b> , to point 1> , to 8% , , to next point. Repeat. <b>END</b>
Set up REVO. Mixing for normal. (For heading-hold gyros, inhibit REVO.)	Open the REVO./NOR function. Adjust to your desired starting point.	<b>REVO.MIX</b> , <b>COND:NORM</b> , to point 1> , to 10% , , to next point. Repeat. <b>END</b>
Confirm gyro direction.	With radio on, move helicopter’s tail to the right by hand. The gyro should give right rudder input (leading edge of the tail rotor blades move left). If the gyro gives the opposite input, reverse direction on the gyro unit itself.	

Goals	Steps	Inputs
Learn how to operate HOVERING PITCH and HOVERING THROTTLE	Notice at half throttle, the <i>VR(B)</i> dial adjusts the throttle separately from the pitch. <i>VR(A)</i> adjusts the pitch separately from the throttle.	 for 1s to BASIC.(If ADVANCE  again) .  to SERVO  .  Throttle stick to center  VR (B),  VR (A).  
Be sure to follow your model's instructions for preflight checks, blade tracking, ect. Never assume a set of blades are properly balanced and will track without checking.		
<i>⚠ Check receiver battery voltage! Always check voltage with a voltmeter prior to each and every engine start.(Never assume being plugged in all night means your radio gear is ready to fly).Insufficient charge, binding servo linkages ,and other problems can result in a dangerous crash with the possibility of injury to yourself, others and property.</i>		
Confirm the swashplate is level at 0 travel. Adjust arms if needed.		
Apply full collective and check that the swashplate remained level and there is no binding. Repeat for full cyclic pitch and roll. If not, adjust as needed to correct in END POINT:		
<p>Important note: prior to setting up throttle hold, idle-ups, offsets, etc, be sure to get your normal condition operating properly.</p> <p>Checking setup prior to going airborne: Check voltage! Then, with the assistance of an instructor, and having completed all range checks, etc, gradually apply throttle until the helicopter becomes "light on the skids." Adjust trims as needed to correct for any roll, pitch, or yaw tendencies. If the tail "wags," the gyro gain is too high. Decrease gyro gain.</p>		

1. Periodically move the throttle stick to full and back down to ensure proper servo settings.
2. It is critical that dials A and C be centered when the pitch and throttle curves are setup.

## 5.2 HELI-SPECIFIC BASIC MENU FUNCTIONS

MODEL TYPE: This function of the PARAMETER submenu is used to select the type of model programming to be used. Before doing anything else to set up your model, first you must decide which MODEL TYPE best fits your MULTIROTOR.

HELICOPTER SWASHPLATE TYPES:

The AT9S radios support 8 basic swash plate setups, including "single servo" (H-1-most helicopters use this type) and 7 types of CCPM (cyclic and collective pitch mixing). A "single servo" swash plate uses one servo for each axis: aileron, elevator (cyclic pitch), and collective pitch. CCPM helicopters utilize a combination of servos working together to achieve the 3 axes of motion. There are 7 basic CCPM types, displayed below. CCPM has several advantages, the most obvious of which is far less mechanical complexity to properly move the swash plate of the helicopter. Additionally, several servos working in unison (ex: HR3, all 3 servos together create elevator movement) dramatically increases the torque available as well as the precision and centering.

Please note that some helicopters are type HR3 or HN3, except off by 180 degrees. If your model 's swash plate is off by 180 you will still use that swash plate type, but also use SWASH AFR to adjust the functions as needed until it operates properly. Additionally, different angles of CCPM may also be created utilizing the fully assignable programmable mixes.

## 5.2.1 Swash Plate Types

### Swashplate Types

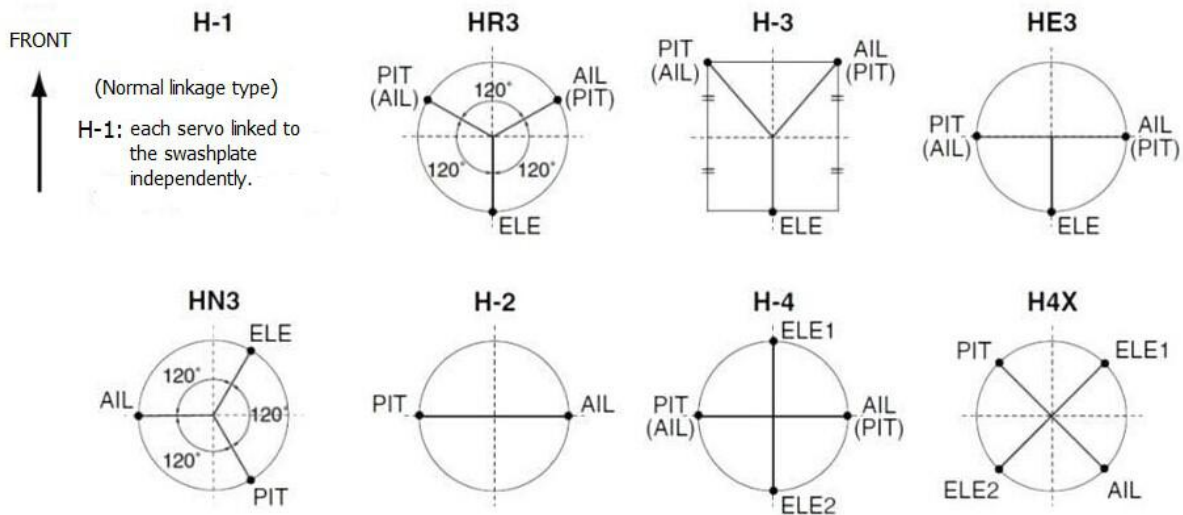

Goals	Steps	Inputs
Change the model type and swashplate of model#3 from MULTIROTOR to 120 degree CCPM with 2 servos working in unison for collective pitch and aileron (Ex: HELI HR3)	Confirm you are using the proper model memory(Ex:3)	On home screen, check model name and # on top left. If it is not the correct model (Ex:3) see MODEL SEL.
	Open PARAMETER, go to MODEL SEL.	<b>MODE</b> for 1s to BASIC.(If ADVANCE <b>MODE</b> again) . to MODEL SEL.
	Select proper MODEL TYPE (HELICOPTER) Confirm	to TYPE. ,  to HELICOPTER.  for 1sec. 'Are you sure?' Displays.
	Change to desired SWASH TYPE (Ex: HR3) Confirm.	to SWASH. ,  to <b>HR3</b> ,  for 1 sec. 'Are you sure?' displays.
	Close	<b>END</b> <b>END</b>

Radio emits a repeating “beep” and shows progress on screen as the model type is being changed. Note that if the power switch is turned off prior to completion, the model type will not be changed.

### 5.2.2 SWASH AFR (not in SWH1):

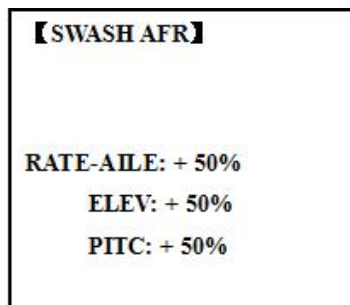

Except SWASH PLATE, function menu of helicopter is same as GLID/ ACRO. Please find the former instructions.

Swash plate function rate settings (SWASH AFR) reduce/increase/reverse the rate (travel) of the aileron, elevator (except H-2) and collective pitch functions, adjusting or reversing the motion of all servos involved

in that function, only when using that function. Since these types utilize multiple servos together to create the controls, simply adjusting a servo's REVERSE or END POINT would not properly correct the travel of any one control. Since H-1 uses one servo for each function, there is no need for AFR in H-1.

Since aileron always uses no more than 2 servos, check it first. Either both operate properly (no change needed), both operate backwards (reverse the whole function), or one servo operates backwards (reverse that servo alone). Next check elevator. Remember, the aileron servo(s) operate correctly, so if elevator does not, we should only have 2 choices left—the whole function needs to be reversed, or the servo(s) not shared with aileron need to be reversed. If aileron and elevator are not working properly, the only thing that could be wrong is the whole direction collective operates (reverse the whole function). In our example, HR3 is 180 degrees off from the swash plate of the Caliber. Therefore, it is very likely that several functions will not operate properly. The collective pitch operation is backwards; but reversing all three servos would also reverse the aileron and elevator operations. Changing the collective pitch rate, however, from +50% to -50%, will reverse the collective pitch without affecting the aileron action.

Checking For Proper Motion On An HR3 Swashplate			
HR3 Swash Typ	Proper Motion	Wrong Motion	How to Fix
AILERON STICK.		Swashplate tilts left.	Reverse AIL setting in SWASH to -50%.
	Swashplate tilts right.	Back of Swashplate moves up.	Ch6 servo moves incorrectly; REVERSE.
		Back of Swashplate moves down.	Ch1 servo moves incorrectly; REVERSE.
ELEVATOR STICK.	Front of swash plate moves down;	Swashplate moves the opposite.	Reverse ELE setting in SWASH. (ex: +50 to -50)
	back of swashplate moves up.	Entire swashplate moves up.	Ch2 servo moves incorrectly; REVERSE.
RUDDER STICK.	The leading edges of tail blades rotate left.	Blades rotated right.	REVERSE the rudder servo.
THROTTLE STICK.	Entire Swashplate lifts.	Swashplate lowers.	Reverse PIT setting in SWASH.

Goals	Steps	Inputs
Adjust the travel of the collective pitch from +50% to -23%, reversing the travel of all 3 servos and decreasing their travel in collective pitch only, on an HR3 SWASH TYPE.	Open SWASH AFR function.	for 1s to BASIC.(If ADVANCE  again) .  to SWASH AFR
	Adjust PITC travel to -23%	to PITC ,  to -23%,
	Close	

## 5.3 HELI-SPECIFIC ADVANCE MENU FUNCTIONS

### 5.3.1 THR-CURVE and PIT-CURVE:

These 7-point curves are utilized to best match the blade collective pitch to the engine RPM for consistent load on the engine. Curves are separately adjustable for normal, idle-up 1, idle-up 2, and idle-up 3. In addition, a separate collective pitch curve is available for throttle hold. Sample curves are displayed in the appropriate setup types (ex: normal flight condition) for clarity.

Suggested defaults:

- Normal: Collective pitch curve that results in points 1, 4 and 7 providing .4, +5, (+8 to +10)\* degrees pitch. A throttle curve setting of 0, 25, 36, 50, 62.5, 75, 100%.
- Idle-ups 1 & 2: Idle-ups 1 and 2 are typically the same except for the gyro settings, with one being heading-hold/AVCS and the other being normal mode. The pitch curve will likely be similar to the normal curve above.
- Idle-up 3: Collective pitch curves that result in points 1, 4 and 7 providing (.8 to .10), 0, (+8 to +10) degrees. A throttle curve of 100, 75, 62.5, 50, 62.5, 75, 100 provide full throttle for inverted maneuvers.
- Throttle Hold pitch curve: Start with the normal pitch curve (for inverted autos, start from the idle-up 3 pitch curve), but increase the last point approximately 1-2°, if available, to ensure sufficient pitch at landing. This default recommendation assumes you are doing forward flight. If you are just learning, please follow your instructor's guidance. Some instructors like a +1 base point for training so that the helicopter comes down very slowly, even if your instincts pull the throttle/collective stick to the bottom in a hurry.

ADJUSTABILITY:

- Normal condition curves are editable in the BASIC menu for convenience.
- All curves may be adjusted in the ADVANCE menu.
- Automatically selected with the proper condition.
- The idle-up curves are programmed to maintain constant RPM even when the collective pitch is reduced during flight (including inverted).
- To change which condition's curve is being edited, cursor up to <COND> and change the curve named.
- For clarity, the name of the condition currently active (switched on in the radio) is shown in parentheses behind name of condition whose curve is being edited. (Example: see curve displays below. Note that the normal condition is active but the idle-up 1 condition's curves are currently being edited.)
- Moving and deleting the curve point: The curve point (-stk-) can be moved to the left or right by turning the DIAL (up to 2% in front of the adjoining point) and deleted/returned by pressing the DIAL for one second alternately.
- Idle-ups and throttle hold pitch curves may be edited even before the conditions have been made active. Activating their throttle curves activates these conditions.

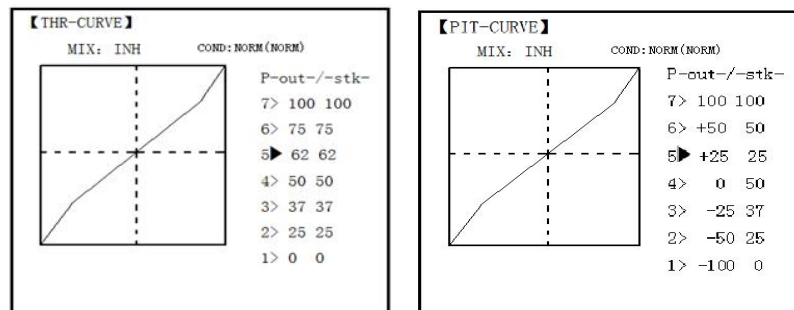

### 5.3.2 REVO MIX:

This 5-point curve mix adds opposite rudder input to counteract the changes in torque when the speed and collective pitch of the blades is changed.

ADJUSTABILITY:

- Three separate curves available: normal for hovering; idle-ups 1 and 2 combined; and idle-3.
- Normal condition curves are editable in the BASIC menu for convenience.
- All curves may be adjusted in the ADVANCE menu.
- Correct mix is automatically selected in-flight with each condition and automatically activated when the throttle setup for that condition is activated in the programming (i.e. THROTTLE HOLD or THR-CURVE.)
- To change which condition's curve is being edited, cursor up above POINT5 and select. For clarity, the name of the condition currently active (switched on at the radio) is shown in parentheses behind the name of the condition whose curve is being edited.

Revo. Mixing rates are 5-point curves. For a clockwise-turning rotor, the rudder is mixed in the clockwise direction when collective pitch is increased; for counterclockwise-turning, the opposite. Change the operating direction setting by changing the signs of the numbers in the curve from plus (+) to minus (-) and vice versa.

Suggested defaults:

Clockwise rotation: -20, -10, 0, +10, +20% from low throttle to high.

Counterclockwise rotation: +20, +10, 0, -10, -20% from low throttle to high.

Adjust to the actual values that work best for your model.

Revo. Curves for idle-ups are often v-shaped to provide proper rudder input with negative pitch and increased throttle during inverted flight. (Rudder is needed to counter the reaction whenever there is increased torque. In inverted flight, throttle stick below half has increased throttle and negative pitch, therefore increasing torque and rotating the helicopter unless the revo. Mix is also increasing appropriately.)

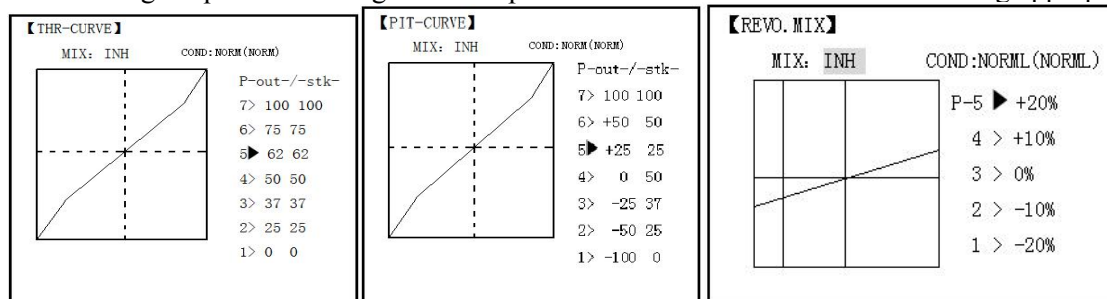

Note: The throttle and pitch curves for the normal condition is always on. They cannot be inhibited. The other four conditions are activated with their throttle curves or throttle hold.

- THR-CURV/NOR: Inputs the normal (NORM) throttle curve, which is usually not a linear response to THROTTLE STICK motion. Adjusting point 4 of the curve adjusts the engine's RPM at the THROTTLE STICK midpoint, the desired position for hovering. The other 6 points are then adjusted to create the desired idle and maximum engine speed, and a smooth transition in-between.
- PIT-CURV/NOR: inputs the normal (NORM) collective pitch curve, the collective pitch curve for flight near hover. The normal collective pitch curve is adjusted to match the throttle curve, providing the best vertical performance at a constant engine speed, with a starting curve of 4 base, +5 neutral, and +8 to +10 degrees of blade pitch maximum. You can program the response over a 7-point curve for the best collective pitch angle relative to THROTTLE STICK movement.
- REVO./NORM: mixes collective pitch commands to the rudder (a PITCH-RUDDER mix) to suppress the torque generated by changes in the main rotor's collective pitch angle, keeping the model from yawing when throttle is applied.

Note: There are three revo, mixes available: normal (NORM), idle-up 1/2 (IDL1/2), and idle-up 3 (IDL3). All 3 are adjustable in the ADVANCE menu. Never use revo mixing in conjunction with heading-hold/AVCS gyros. For details on revo, including default points for clockwise and counterclockwise rotating rotors.

Goals	Steps	Inputs
<b>Setup Normal Flight Condition Throttle/Collective Pitch Curves and Revo.</b> <i>Base point:</i> Adjust base point of throttle curve until engine idles reliably on ground. Adjust base point of collective pitch curve to achieve -4 degrees of blade pitch. Apply throttle until the model sits 'light' on its skids. Adjust base point of REVO. until model does not rotate its nose at all.	Open the THR-CURVE, Adjust the first point.(5%)	(MODE) for 1s to BASIC.(If ADVANCE (MODE) again) . (P) to THR-CURVE (P) to point 1 (P) to 5%, (END) .
	Open the PIT-CURVE, Adjust the first point.(8%)	(P) to PIT-CURVE (P) to point 1 (P) to 8%, (END)
	Open the REVO.MIX Adjust the first point.(4%)	(P) to REVO.MIX (P) to MIX (P) to ON. (P) to point 1 (P) to 4%, (END) .

<p><i>Hover point:</i> Adjust collective pitch curve to +5 degrees. Ease heli into a hover. Land/shut engine off. Adjust throttle curves and rudder trim. Repeat until model hovers smoothly at half throttle. Rapidly apply throttle from 1/4 to 1/2 stick. Adjust REVO. points 2 and 3 until the model does not rotate its nose up on throttle application.</p>	Adjust THR-CURV/NOR	Repeat above as needed
	Adjust PIT-CURV/NOR	Repeat above as needed
	Adjust REVO.MIX	Repeat above as needed
<p><i>High point:</i> Adjust collective pitch curve to +8 to +10 degrees. From hover, throttle up rapidly. If engine bogs, increase the throttle curve. If engine over-revs, increase the collective pitch curve at points 6 or 7. Apply full throttle while hovering, then descend back to hover. Adjust REVO. until the nose does not change heading.</p>	Adjust THR-CURV/NOR	Repeat above as needed
	Adjust PIT-CURV/NOR	Repeat above as needed
	Adjust REVO.MIX	Repeat above as needed

### 5.3.3 GYRO SENSE

About GYRO SENSE, please refer to 3.3.12, by following steps:

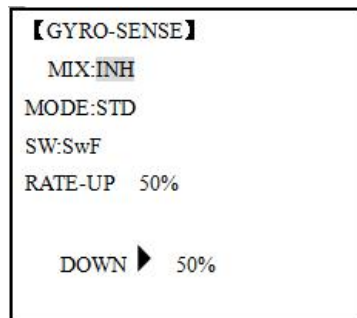

Goals	Steps	Inputs
Set up heading-hold /AVCS gyro with heading-hold/AVCS setting in idle-ups 1 and 2 and normal mode setting in idle- up3	Open and activate the GYRO SENSE function.	(MODE) for 1s to BASIC.(If ADVANCE (MODE) again) . (MODE) to GYRO-SENSE (MODE)
	Activate the function.	(MODE) to MIX (MODE), (MODE) to ACT. (MODE)
	<i>Optional: Change gyro types to Heading- hold (GY).</i>	(MODE) to MODE (MODE), (MODE) to GY (MODE)
	<i>Optional: Changes switch assignment. Ex: select Cond.</i>	(MODE) to SW (MODE), (MODE) to Cond (MODE)



	Adjust gyro rates as needed. (Ex: NORM, IDL3 to NOR 50%. IDL1 and 2 to AVC 50% as starting points.)	to <b>NORM</b> ,  ,  to NOR 50% to <b>IDL1</b> ,  ,  to AVC 50% Repeat.
	Close	

### 5.3.4 THROTTLE HOLD

This function holds the engine in the idling position and disengages it from the THROTTLE STICK when SWITCH AT9S is moved. It is commonly used to practice auto-rotation. Prior to setting up THR-HOLD, hook up the throttle linkage so that the carburetor is opened fully at high throttle, then use the digital trim to adjust the engine idle position. To have THR- HOLD maintain idle, move the THROTTLE STICK to the idle position, then move the hold SWITCH on and off and keep changing the offset value until the servo does not move. To lower the engine idle speed, or if you want to shut off, input a more negative number.

#### ADJUSTABILITY:

- Idling position: Range of -50% to +50% centered about the throttle idle position to get the desired engine RPM.
- Switch assignment: Assigned to SWITCH E(AT9S) or G (AT9S) down. Adjustable in the CONDITION (THR-HOLD item), (2-position type switch only)
- Throttle curve: Since the throttle is moved to a single preset position, no curve is available for THR-HOLD.
- Collective pitch curve: Independent curve, typically adjusted to create a blade pitch range of -4% to +10% to +12%, is automatically activated with THR-HOLD.
- Revo. mix: Since revo. mix adjusts for torque from the engine, no revo. mix is available for THR-HOLD.
- Priority: The throttle hold function has priority over idle-up. Be sure that the throttle hold and idle-up SWITCHES are in the desired positions before trying to start the engine. (We recommend starting your engine in throttle hold for safety reasons.)
- Gyro: Gyro programming includes an option to have a separate gyro setting for each condition, including THR-HOLD. This avoids the potential problem of the user being in the wrong gyro setting when going to THR-HOLD, resulting in an improper rudder offset and the model pirouetting.

Goals	Steps	Inputs
Set up throttle hold.  Determine desired throttle position by idling engine, turn on THR-HOLD, and adjust percentage as required to reach the desired running point.	Open THR-HOLD function.	for 1s to BASIC.(If ADVANCE  again)  to THR-HOLD
	Activate the function.	to MIX  ,  to OFF
	Set desired engine	to POSI  ,  to desired percent
	Close	

### 5.3.5 HOVERING ADJUSTMENTS (HOV-THR and HOV-PIT):

Hovering throttle and hovering pitch are fine-tuning adjustments for the throttle and collective pitch curves individually, affecting performance only around the center point and only in the normal condition. They allow in-flight tweaking of the curves for ideal setup.

```

【HOV-THR】

MIX:INH
RATE: 0%(+11%)
VR:+VrB
MODE:NORM

```

```









【HOV-PIT】

MIX:INH
RATE: 0%(-63%)
VR:+VrA
MODE:NORM

```

**ADJUSTABILITY:**

- Rotor speed changes caused by temp., humidity, altitude or other changes in flying conditions are easily accommodated.
- Both adjustments may be inhibited if not desired.
- Both adjustments may also be set to NULL, temporarily turning off the knob but maintaining the last memorized setting.
- Adjustments may be memorized and then the knobs returned to center point to use that amount of adjustment, allows easy use of the trimming knobs for multiple models. (Note that when memorization is repeated with the knob offset from center, the trim value accumulates.)
- Adjustments are quickly reset to the initial value by turning the dial until the trim reads 0%, memorizing, then returning the knob to its center position.
- Note that all functions, including these, assume the model hovers at half stick.
- Available in normal (NORM) or normal/ idle-up1 (NORM/IDL1) condition only.

Goals	Steps	Inputs
Fine-tune hovering with the hovering adjustments. Remember these affect only the hovering (normal) condition.	Open the HOV-THR function	<b>(MODE)</b> to BASIC. <b>(MODE)</b> again to ADVANCE  to HOV-THR. 
Adjust throttle and collective pitch curves until model hovers nicely. In flight, adjust collective pitch and throttle curves near hover point independently with HOV-THR and HOV-PIT knobs.	<i>Optional: change which knob adjust seach hovering curve. NULL locks in curve in last stored position.</i>	 to VR  ,  to desired knob and direction 
Store new settings after flight.	Close	<b>(END)</b>
	Open the HOV-PIT function.	 to HOV-PIT.  Repeat.
	Close	<b>(END)</b> <b>(END)</b>

**5.3.6 HIGH/LOW PITCH (HI/LO-PIT):**

This function may be used to adjust the curves high and low side individually for each flight condition (normal, idle-up 1, idle-up 2, idle-up 3, throttle hold).

```

【HI/LO-PIT】
COND:NORM ( NORM)
HI-PIT:100% ( 100%)
  ADJ:MANUAL  VR:+VrD
LO-PIT:100% ( 100%)
  ADJ:MANUAL  VR:-VrC













```

**ADJUSTABILITY:**

- You may define high and low side rate trim knobs (the high side pitch trim control is defined as the right

side lever at initial setting).

- The conditions are activated in the CONDITION SELECT function.
- Both adjustments may be set to MANUAL, temporarily turning off the knob.
- Adjustments may be memorized and then return the knobs to center point to use that amount of adjustment, allows easy use of the trimming knobs for multiple models.

Goals	Steps	Inputs
Set up a high pitch curve in the idle-up 1 condition.	Open the HI/LO-PIT	<b>MODE</b> to BASIC menu, <b>MODE</b> again to ADVANCE menu.  to HI/LO-PIT. 
	Select the idle-up 1 condition	 to COND  ,  to IDL1 
	Set the rate (Ex:80%)	 to HI-PIT  ,  to 80% 
	Optional: Change which knob adjusts high pitch curve.	 to VR  ,  to desired knob and direction.
	Close	<b>END</b> <b>END</b>

### 5.3.7 OFFSET

Optional separate trims in addition to those for the normal condition. This function is used to automatically change the trim of a helicopter, for example, when transitioned from hover to flying at high speed. A clockwise-rotation rotor helicopter tends to drift to the right at high speed, so an aileron offset may be applied to offset the helicopter to the left.

The necessary elevator offset varies with model geometry, so it must be determined by noting collective pitch changes at high speed. The rudder offset is affected by both revo. mixing and trim lever movement while in the offset function.

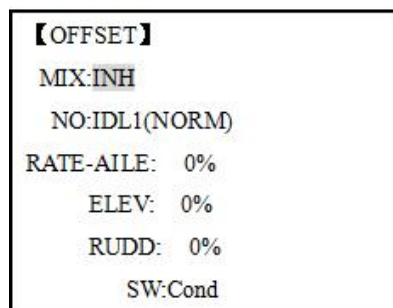

#### ADJUSTABILITY:

- Complete switch assign ability, plus a CONDITION option that creates/ switches between individual trims for each of the idle-ups.
- When OFFSET is active (its switch is on), moving the TRIM LEVERS adjust the stored offset, not the trims in the normal condition.
- When OFFSET is inactive (its switch is off), the OFFSET and any trim adjustments to it have no effect (model obeys the trim settings of the currently-active flight condition.)
- When OFFSET is inhibited, trim adjustments made in any flight condition affect all flight conditions.
- Rapid jumps caused by large offsets can be slowed using the DELAY function.
- During OFFSET operation, the aileron, elevator, and rudder travels are displayed on each trim display in the Startup screen.

Note: Remember, offsets and revo mixes are not recommended when using heading-hold/AVCS gyros because they conflict with the automatic corrections to trim and torque that AVCS provides.

Goals	Steps	Inputs
Set up separate trims for each of the three idle-up conditions.  Adjust the idle-up 2 rudder trim to correct for torque at high speeds.	Open the OFFSET function.	(MODE) to BASIC menu, (MODE) again to ADVANCE menu F1 to OFFSET. F2
	Activate the function.	F3 to MIX, F4, F5 to ON. F6
	Change switch setting to Cond.	F7 to SW, F8, F9 to Cond, F10
	Select IDL2.	F11 to NO. F12, F13 to IDL2, F14
	Adjust trim settings as needed. (Ex:rudder to +8%.)	F15 to RUDD, F16, F17 to +8%, F18
	Close menus and confirm slowed transitions.	(END) (END) E (AT9S) from NORMAL to IDL2.Check the changes of rudder trim.

### 5.3.8 DELAY:

The Delay function provides a smooth transition between the trim positions whenever OFFSET, REVO, MIXING, or THROTTLE HOLD functions are turned on and off.

【DELAY】	
RATE-AILE:	0 %( OFF )
ELEV:	0 %( OFF )
RUDD:	0 %( OFF )
THRO:	0 %( OFF )
PITC:	0 %( OFF )

#### ADJUSTABILITY:

- Separate delay times are available for aileron, elevator, rudder, throttle, and pitch.
- With a 50% delay setting, the servo takes about a half-second to move to its new position, quite a long time.
- In general, delays of approximately 10-15% are sufficient.

Goals	Steps	Inputs
Set up a delay on all channels to ease the transition from one flight condition to another so there are no 'hard jumps'.	Open the DELAY function.	(MODE) to BASIC menu, (MODE) again to ADVANCE menu F1 to DELAY. F2
	Adjust AILE response as needed. (Ex: aileron to +8%.)	F3 to RATE-AILE, F4, F5 to 8%, F6
	Repeat for other channels.	F7 to ELEV. Repeat steps above.
	Close menus and confirm slowed transitions.	(END) (END) E(AT9S) from NORMAL to IDL2.Check that the servos move gradually to new

### 5.3.9 GOVERNORS:

The Governor mixing function is used to adjust the Governor speed settings (rS1, rS2, rS3) from the transmitter.

What is a governor? A governor is made up of a set of sensors which read the RPM of the helicopter's head, and a control unit that automatically adjusts the throttle setting to maintain a constant head speed regardless of changes in pitch of blades, weather conditions, etc. Governors are extremely popular in competition helicopters due to the consistency provided.

How does it help in helicopter setup? The governor eliminates the need to spend large amounts of time setting up throttle curves, as it automatically adjusts the engine's RPM to maintain the desired head speed.

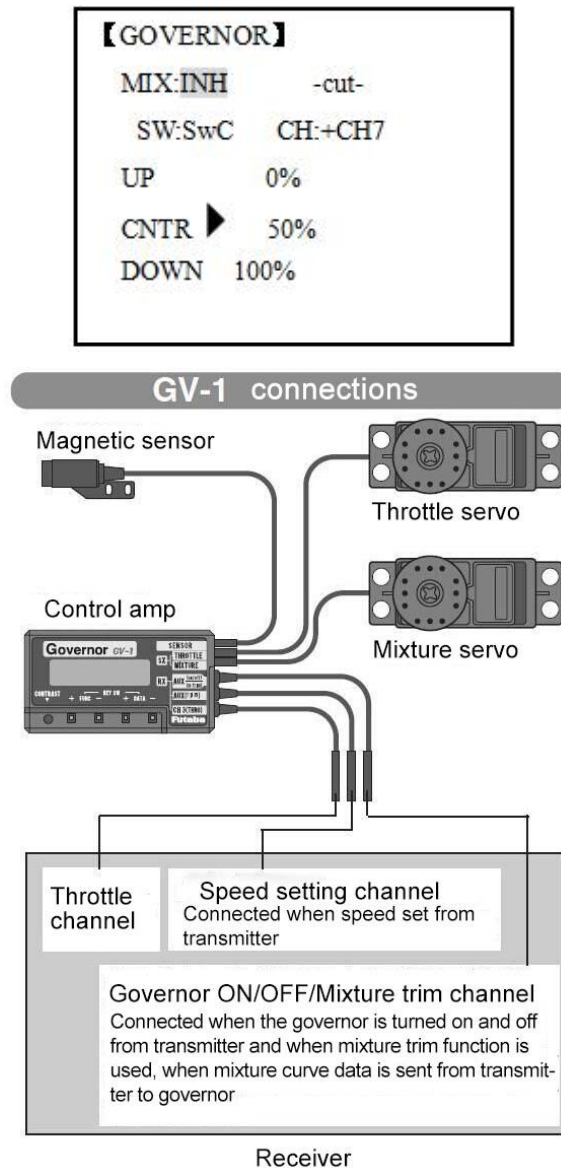

#### ADJUSTABILITY:

- On/off may be separate from speed switching by plugging governor on/off into CH8 and changing CUT-CH setting.
- If using separate on/off, switch assignment is totally adjustable. Be careful not assign governor off to a condition switch if you want the governor to function in that condition.
- Speed switching and governor ON/OFF may be together using one switch or ON/OFF switching may be performed using an independent switch/channel.
- When speed setting control uses CH7 and separate ON/OFF switch is not used, CH8 can be used for other functions.
- In-flight adjustment of the head speed (for easy adjustment during turning) may be created using an additional channel and a programmable mix.

The GV-1 controls throttle when it is active, so the throttle will not obey any Failsafe settings preset for throttle in the transmitter. Always set the Failsafe setting for the GV-1's on/off channel to OFF. This way the governor is shut off and the throttle obeys the Failsafe throttle commands.

Goals	Steps	Inputs
Set up a governor to use both channels into the receiver and switch between the governor settings automatically when changing conditions. Consider setting the battery Fail Safe settings and other helpful functions on the governor itself.	Open and activate the GOVERNOR Function.	(MODE) to BASIC menu, (MODE) again to ADVANCE to GOVERNOR
	Activate the function.	to MIX ,  to ACT.
	<i>Optional: change cut-off channel to channel 8 and assign switch and direction for on/off (channel 8).</i>	to -cut- CH: ,  to +CH8, to -cut-SW ,  to desired SW
	<i>Optional: Changes switch assignment to select governor settings. Ex: select switch that selects the conditions.</i>	to SW ,  to Cond,
	Adjust governor speed settings per switch position or condition as needed. (Ex: defaults are fine.) Allows head speed adjustment from transmitter.	to each Cond position  or  as needed. to next Cond, repeat .
	Close	(END) (END)

### 5.3.10 Throttle Mixing (THROTTLE MIX):

[THRO-MIX]		
MIX:INH		
AIL→TH	ELE→TH	RUD→TH
→NORM: 0%	0%	0%
IDL1: 0%	0%	0%
IDL2: 0%	0%	0%
IDL3: 0%	0%	0%

This function can be set for each flight condition, and is used to correct the tendency of the model to change altitude when the rotor is tilted by aileron, elevator, and rudder controls.

#### ADJUSTABILITY:

- Mixing may be set from 0 to 100% each flight condition.

Goals	Steps	Inputs
Correct the tendency of the model to change altitude.	Open THRO- MIX function.	(MODE) to BASIC menu, (MODE) again to ADVANCE to THRO-MIX
	Activate the function.	to MIX ,  to ON
	Adjust the rate. Ex: IDL1 (AIL to TH) 10%	to IDL1 (AIL→TH) ,  to 10%,

	Repeat as needed.	
Close	(END)	(END)

### 5.3.11 SWASH-RING

This function is to limit movement of swash plate to avoid damage to the SWASH ROB during operation aileron and ELEVATOR. It is affected in 3D flight. Movement of AILERON and ELEV is limited in the circle.

ADJUSTABILITY:

- Initial: 100%
- adjusting range: 0-200%

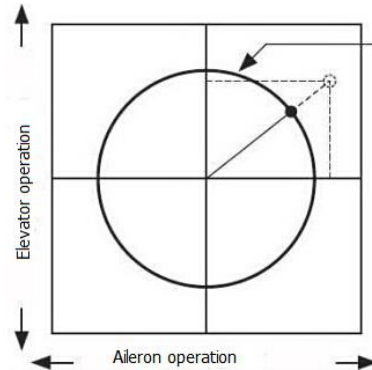
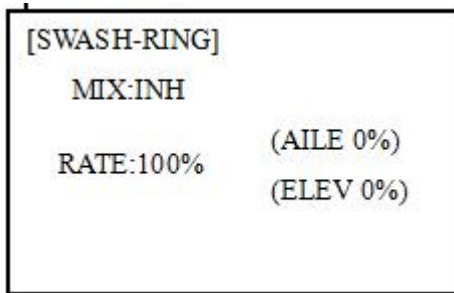

Goals	Steps	Inputs
To prevent damaging the swash linkage by simultaneous operation of the ailerons and elevators, set the limit point where swash throw stops.  * Adjust the rate at the maximum swash tilt by simultaneous operation of the ailerons and elevators.	Open SWASH-RING function.	(MODE) to BASIC menu, (MODE) again to ADVANCE (SWASH-RING) to SWASH-RING (SWASH-RING)
	Activate the function.	(MIX) to MIX (MIX), (ACT) to ACT (ACT)
	Adjust the rate Ex: 90%	(RATE) to RATE (RATE), (90%) to 90%, (90%)
	Close	(END) (END)

### 5.3.12 THROTTLE NEEDLE (see ACRO MENU 3.3.15)

### 5.3.13 PROG MIX (see ACRO MENU 3.3.1)

### 5.3.14 CONDITION

Revo., curves for idle-ups are often v-shaped to provide proper rudder input with negative pitch and increased throttle during inverted flight. (Rudder is needed to counter the reaction whenever there is increased torque. In inverted flight, throttle stick below half has increased throttle and negative pitch, therefore increasing torque and rotating the helicopter unless the revo. mix is also increasing appropriately.) Additional flight conditions are available specifically for helicopters. These additional flight conditions contain different throttle curves, collective pitch curves, revo. mixing, and trims (except IDLE-3) to make the helicopter perform certain maneuvers more easily. Lastly, the gyro and dual rate functions may be set to provide separate rates per condition selected, including one for each idle-up.

Additional idle-ups may be used to maximize the helicopter's flight characteristics in certain types of flight (i.e. fast forward motion, backward) or maneuvers (loops, rolls, stall turns), or even the same maneuver but changing from heading-hold/AVCS gyro mode to normal gyro mode. The AT9S provides 3 idle-ups to allow the modeler 3 additional setups along with the normal flight condition. (Note that IDL3 does not include governor settings.)

[CONDITION]	-sw-	-pos-
IDLE-UP1:INH	SwE	CENT
2:INH	SwE	DOWN
3:INH	SwF	DOWN
THR-HOLD:INH	SwG	DOWN

ADJUSTABILITY:

- SWITCH G (AT9S) or E (AT9S) is programmed for normal (NORM), idle-up 1 (IDLE-UP1), and idle-up 2 (IDLE-UP2) curves, adjustable in CONDITION SELECT (IDLE-UP1/2, IDLE-UP3 items). (IDLE-UP1/2 3-position type switch only, IDL3 2-position type switch only)
- Activated with the throttle curve for that condition in THR-CURVE.
- Curves are adjusted to maintain constant RPM even when the collective pitch is negative (inverted). Note that REVO mixing has one curve for idle-ups 1 and 2 and a second curve just for idle-up3.
- Gyro settings may be set separately for each idle-up.
- Governor settings may be set up to follow Normal/Idle1/Idle2, but do not offer a setting to adjust for each of the 5 conditions like gyro.
- Activating OFFSET makes the TRIM LEVERS adjust the trim separately in each of the idle-up conditions.



## Part 6. MULTIROTOR FUNCTIONS

This menu makes it easier to fly multi copters. The basic function menu is same like ACRO, GLID and HELI. Now let's start the basic setting, take a quad copter for example:

Goals	Steps	Inputs
Prepare your MULTIROTOR.	Install all servos switched, receivers, etc. per your model's instructions. Turn on the transmitter then receiver; adjust all linkages so surfaces are nearly centered. Mechanically adjust all linkages as close as possible to proper control throws. Check servo direction. Make notes now of what you will need to change during programming.	
Select proper MODEL TYPE. (Ex: MULTIROTOR)	Open the BASIC menu find the MODEL TYPE.	Turn on the transmitter, (MODE) for 1 sec. to BASIC menu (If ADVANCE, (MODE) again) ⌂ to MODEL TYPE ⌂
	Go to TYPE	⌂ to TYPE
	Choose proper model type (Ex: MULTIROTOR). Confirm the change.	⌂ to MULTIROTOR, ⌂ for 1 sec. 'Are you sure?' Displays, ⌂ to confirm.
Name the model. Note that you do not need to do anything to 'save' or store this data.	In BASIC menu, Open MODEL SEL.	⌂ to MODEL SEL. ⌂, ⌂ to NAME (the 1 <sup>st</sup> character of model name is highlighted)
	Input MULTIROTOR's name. Close	⌂ to change the 1 <sup>st</sup> character. ⌂. ⌂ move to next character, repeat as needed. (END) to BASIC.
For proper control operation, reverse servos as needed.	In the BASIC menu, open REVERSE.	⌂ to REVERSE ⌂, ⌂ to choose REV.
	Choose desired servo and reverse its direction of travel.(Ex: reverse rudder servo)	⌂ to CH4: RUDD, ⌂, so REV highlighted, 'Are you sure?' Displays. ⌂ Repeat as needed. (END) to BASIC.
Adjust travels as needed to match model's recommend throws(usually listed as high rates)	From BASIC menu choose END POINT.	⌂ to END POINT, ⌂
	Adjust the servo's end points.(Ex: throttle servo) Close	⌂ to CH1:AILE ⌂, ⌂ VR(A), ⌂ to desired percentage. ⌂ VR(A) to repeat above steps.
	Back to choose D/R EXP.	⌂ to D/R,EXP ⌂
Set up dual/triple rates and exponential (D/P, EXP) (Note that in the middle of the left side of the screen is the name of the channel and the switch position you are adjusting. Two or even THREE rates may be set per channel by simply choosing the desired switch and programming percentages with the switch in each of its 2 or 3 positions.	Choose the desired control, and set the first (Ex: high) rate throws and exponential.	⌂ to CH ⌂, ⌂ to CH:2 (ELEV) ⬆ SwA screen reads ELEV (UP) ⌂ to D/R ⌂ Elevator Stick ⌂ to set rate. ⌂ ⌂ Elevator Stick ⌂ to set rate. ⌂ (Normally set the same as down. ⌂ to EXP ⌂ Elevator Stick ⌂ to set rate. ⌂ ⌂ Elevator Stick ⌂ to set rate. ⌂
		set the first (Ex: low) rate

	throws and exponential.	
	Optional: change dual rate switch assignment.	to SW ,  SwG,  SwG to center position. Repeat steps above to set 3 <sup>rd</sup> rate. <b>END</b>
Adjust AUX-CH and Knob.	On BASIC menu, then open AUX-CH function.	to AUX-CH,
	Choose CH5 to set ATTITUDE	to CH5,  to ATTITUDE
	Assign the switch to control attitude. Ex: SW3 is SWC, SW2 is SWB	to SW3, ,  to SWC, to SW2, ,  to SWB,
	Set the rate in each attitude. Ex: ATTI is 50%.	to ATTI ,  to 50%
	Change CH6, use VR (D) to control change other channels as needed.	to CH6 ,  to VR(D). Repeat as needed.
	Close	<b>END</b> <b>END</b>

## 6.1 MULTIROTOR BASIC MENU

The basic function menu is same like ACRO, GLID and HELI, please find the detail in the former chapters. Below is the special option:

### 6.1.1 MODEL TYPE

Different from ACRO, GLID AND HELI, MODEL TYPE for MULTIROTOR has an additional function TRIM, which is controlled by the VR switch. Set the TRIM OFF to avoid a mis-operation damage to the model.

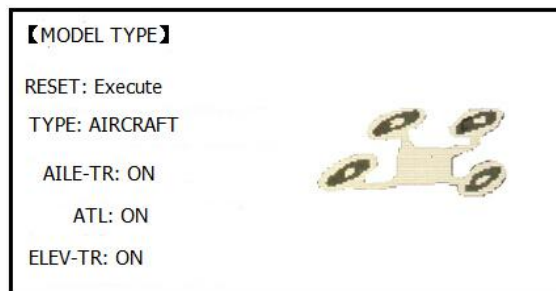

Goals	Steps	Inputs
Select proper MODEL TYPE. (Ex: MULTIROTOR)	Open BASIC menu, find MODEL TYPE.	Turn on the transmitter, <b>MODE</b> for 1 sec. to BASIC menu (If ADVANCE, <b>MODE</b> again) to MODEL TYPE
	Go to MODEL TYPE	to TYPE
	Choose proper model type (Ex: MULTIROTOR). Confirm the change.	to MULTIROTOR,  for 1 sec. ‘Are you sure?’ Displays,  to confirm.
	Turn on the trim.	to AILE-TR ,  to ON. Repeat above to turn on other trims
	Close	<b>END</b> <b>END</b>

### 6.1.2 AUX Channel setting

AUX channel for MULTIROTOR is channel 6 to 12, same like ACRO, GLID and HELI, to set auxiliary channel. CH5 is special for ATTITUDE, enter CH5 and press PUSH for ATTITUDE. Select 3-section and 2-section switch to get 6 different attitudes. By DIAL set 6 different rates according to the attitudes.

## 6.2 ADVANCE MENU FOR MULTIROTOR

### 6.2.1 ATTITUDE

There are 6 different attitude modes for MULTIROTOR: NORMAL, ATTI, GPS, HOVER, F/S and AUX. Every mode will have a different rate to get a unique signal. NORMAL mode preset 0%, ATTI 50%, GPS 100%, HOVER 25%, F/S 75% and AUX 50%.

0% means a output signal 1ms, and 100% means 2ms. You can totally get 6 different modes by adjusting the related rates.

[ATTITUDE]		
SW3:SwC	SW2:NUL	
-rate-	-posi-	-swt-
NORMAL: 0%	(UP-UP)	(OFF)
ATTI.: 50%	(CT-UP)	(ON)
GPS:100%	(DN-UP)	(OFF)
HOVER: 25%	(UP-DN)	(OFF)
F/S: 75%	(CT-DN)	(OFF)
AUX: 50%	(DN-DN)	(OFF)

Goals	Steps	Inputs
Set the ATTITUDE of MULTIROTOR.	In ADVANCE menu find the ATTITUDE function.	Turn on the transmitter, (MODE) for 1 sec. to BASIC menu (If ADVANCE, (MODE) again) ⌂ to ATTITUDE ⌂
	Assign the switch to control attitude. Ex: SW3 is SWC, SW2 is SWB	⌂ to SW3, ⌂ to SWC, ⌂ ⌂ to SW2, ⌂ to SWB, ⌂
	Set the rate in each attitude. Ex: ATTI is 60%.	⌂ to rate-ATTI, ⌂ to 60%, ⌂
	Close	(END) (END)

### 6.2.2 THROTTLE CURVE (see ACRO 3.3.14)

### 6.2.3 PROG. MIX (see ACRO 3.3.1)

## AT9S Using Tutorials

**RadioLink AT9S Vs AT9 English Subtitles**

<https://www.youtube.com/watch?v=UkY319wiHEU&t=14s>

**RadioLink AT9 + R9D Binding(same as the AT9S and R9DS binding)**

<https://www.youtube.com/watch?v=3nTh7FBiSlw>

**RadioLink AT9 Firmware Update(same as the AT9S firmware upgrade)**

<https://www.youtube.com/watch?v=QvazyIYqLJ8>

**RadioLink AT9 Stick Calibration(same as the AT9S Stick Calibration)**

<https://www.youtube.com/watch?v=cbXGhqQ-SBw>

**RadioLink AT9 with Naza in Sbus(same as the AT9S)**

<https://www.youtube.com/watch?v=NCXxlZp6TAA&t=423s>

**RadioLink AT9-R9D + APM. How to connect receiver to flight controller(same as the AT9S)**

<https://www.youtube.com/watch?v=-UwyhqZnDSk&t=42s>

**Setup Radiolink AT9, R9D sbus and cleanflight(same as the AT9S)**

<https://www.youtube.com/watch?v=7xnbLYKOVaM>

**How to use for simulator(same as the AT9S)**

[https://www.youtube.com/watch?v=eg\\_O\\_kzh1A&t=355s](https://www.youtube.com/watch?v=eg_O_kzh1A&t=355s)

**Radiolink How to change mode 2 to mode 1 in AT9 (same as the AT9S)**

<https://www.youtube.com/watch?v=NZDB7fG4QTk>

**Radiolink AT9 trainer function (same as the AT9S)**

<https://www.youtube.com/watch?v=3WqJO0p0Xv8&t=24s>

**S550 NazaV2 RadioLink AT9S**

<https://www.youtube.com/watch?v=VwOKJZgxeRI&t=1s>